

DEFIANTWARRIOR and the NSA's Use of Bots

Overall Classification: TOP SECRET//COMINT//REL FVEY

Current As Of: 24 May 2010

Derived From: NSA/CSSM 1-52

Dated: 20070108

Declassify On: 20350401

Unless otherwise noted, treat all contained items within slides as classified at the level of the containing slide as indicated at the top of the slide.

Overview

- BotNet Background
- Bot Herding 101
- NSA's Adventures in Bot Herding (FAIL)
- Successful Endeavors

Bot Networks - Worldwide



- ▶ Average of 63,912 active bot network computers per day, an 11% increase. Worldwide total rose to just over 6,049,594 - a 29% increase.
- ▶ 4,746 Command and Control servers were observed; 40% U.S. based
- ▶ China has moved to the top – to 26% while the United States continues to decline. EMEA countries, with the exception of the U.K., showed the largest increase.

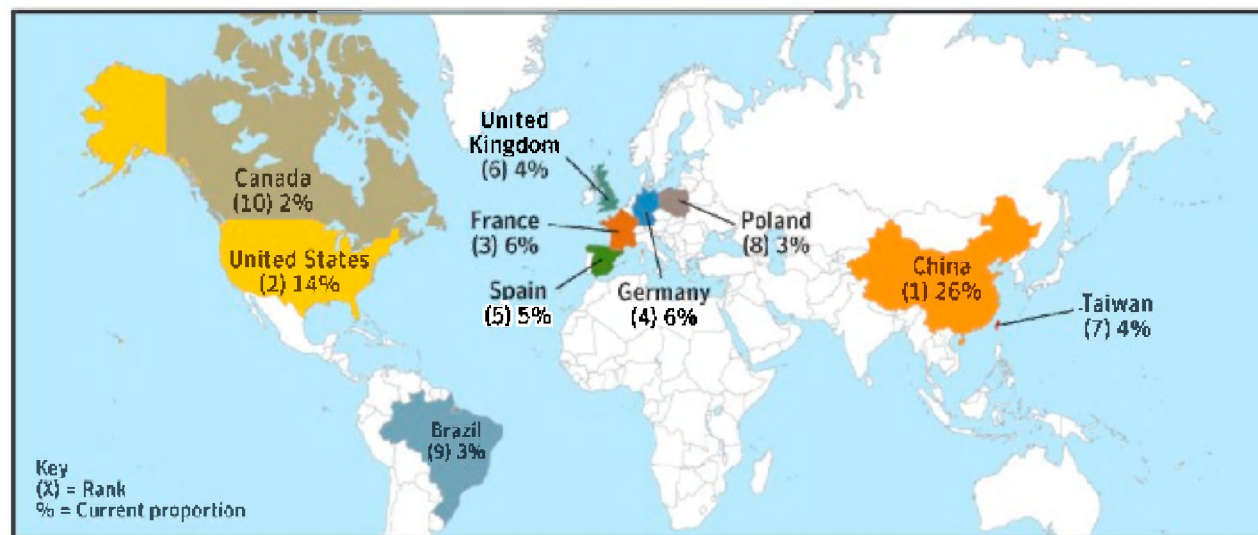

Bot Herding 101 – it's a Business

- Used Extensively for Illicit Means
 - Distributed Denial of Service (DDoS)
 - SPAM Operations
 - Financial Fraud
 - Intelligence Collection (Brazil, Russia, China, etc)
- Three Modes of Control
 - Phase 1 - IRC
 - Phase 2 - HTTP (OLYMPUS/UNITEDRAKE are Bots)
 - Phase 3 - Peer-to-Peer

Bot Herding 101 - Infrastructure

- Master Herder Controls Subordinate Command & Control Nodes
- Each C2 Nodes Relays Herder's Instructions to Bots
 - Individuals
 - En-Mass
- BotNets Have Been Observed with Millions of Nodes

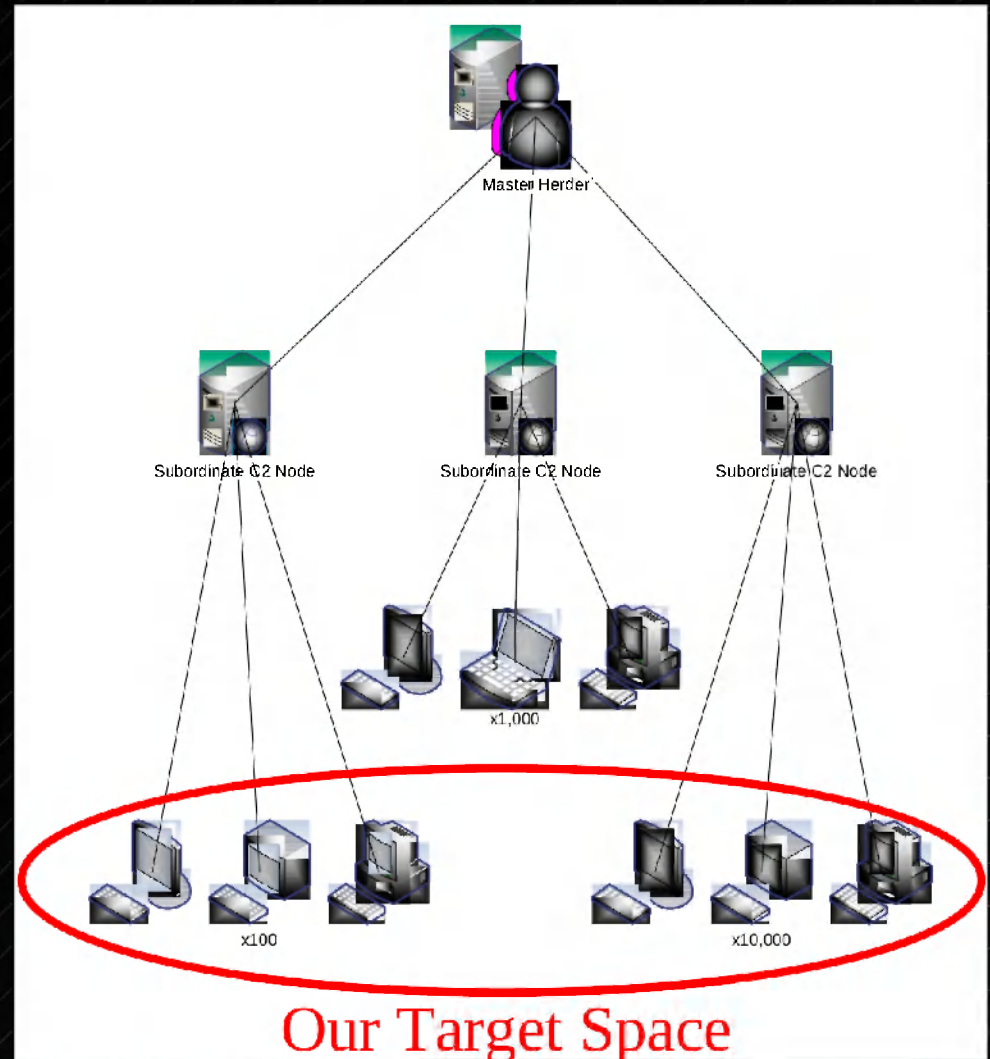

Bot Herding 101 – Hostile Take Over

- BotNets are Regularly Exchanged, via
 - Rent
 - Sale
 - Hostile Take Over – aka BotWar
- Sting Operations
 - Use Valid BotHerder Credentials
 - Take Control of the C2 Channel

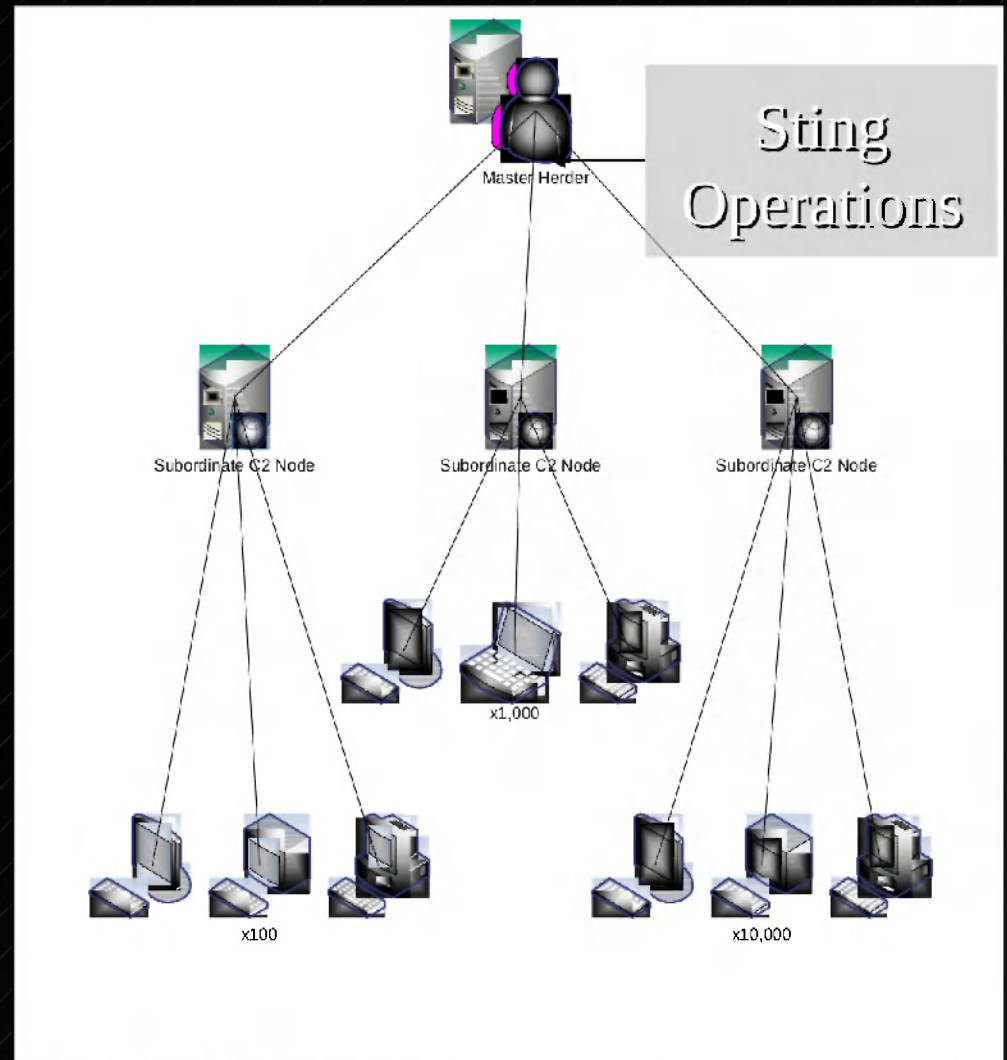

Bot Herding 101 – A Joint Venture

- FBI Open BotNet Cases
- US Government Control
- Bots Directed to “Bot Prison”
 - Custom IRC Server
- Bot IPs Processed Through Quarantine Engine
 - .foreign – Directed to TAO IRC Server
 - .gov/.mil – NTOC Business Logic
 - .us – FBI Office of Victim Assistance
 - FBI Goes Public – Avoid BotWar

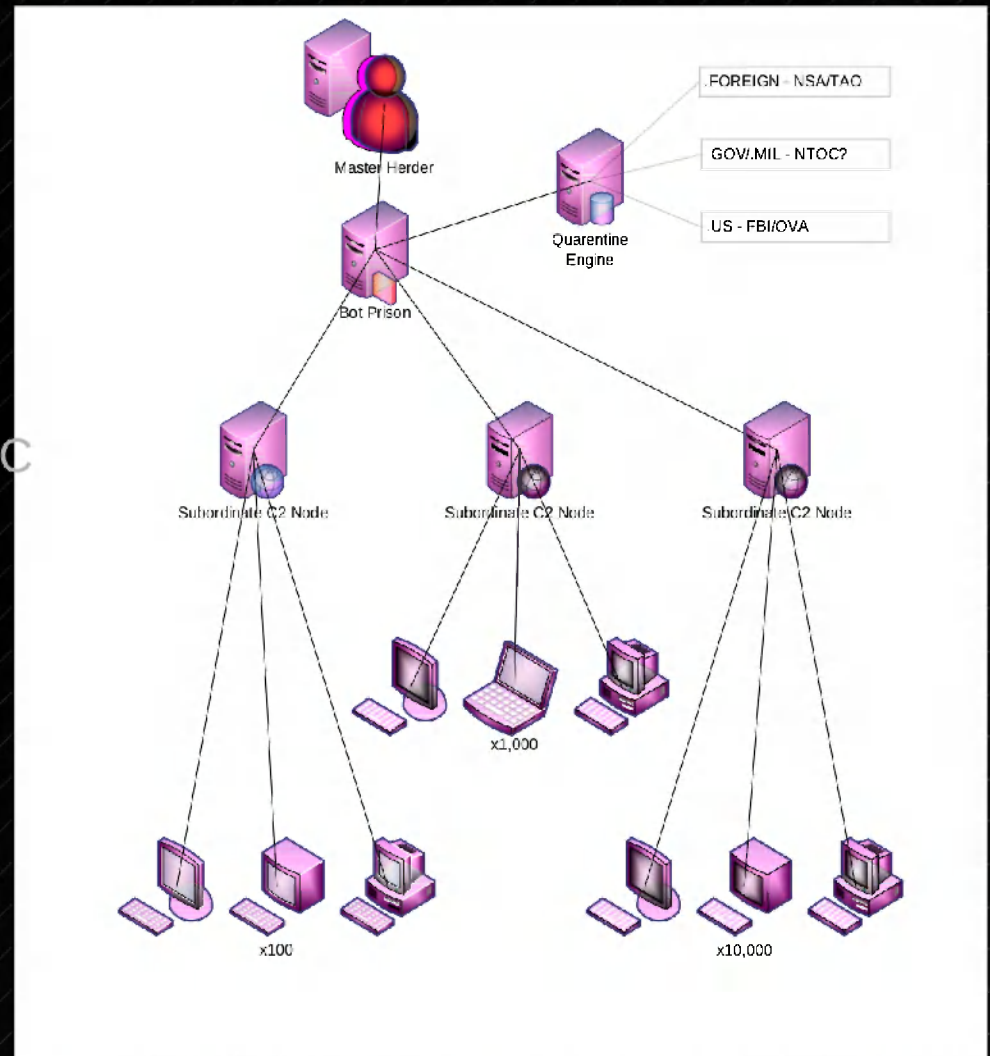

Bot Herding 101 – Success!!! An All SIGINT Approach

- Leverage FVEY SIGINT Systems to Identify and Target Foreign Bots
- Extensively Utilize GCHQ Mid-Point Collection Platforms (and Personnel)
- Heavy Integration with TURBULENCE Architecture (aka QUANTUMBOT)
 - TURMOIL – Passive Tipping
 - TURBINE – High/Low/High Interaction
 - Snipers – Man-on-the-Side Injection

What the DW OPSEC Profile Buys:

- “go broad” active CNE
- Pervasive network analysis vantage points
- Throw-away non-attributable CNA nodes

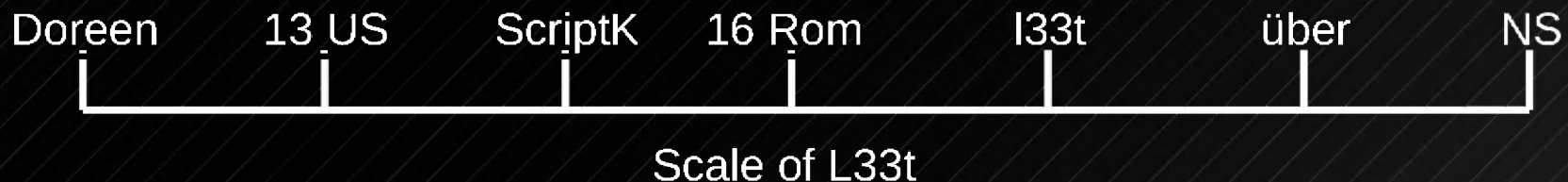

Bot Acquisition Setup

- Check XKEYSCORE for exploitable bots
- Task TURMOIL to watch for such traffic
- Task TURBINE to generate MOTS packet

QUANTUMBOT

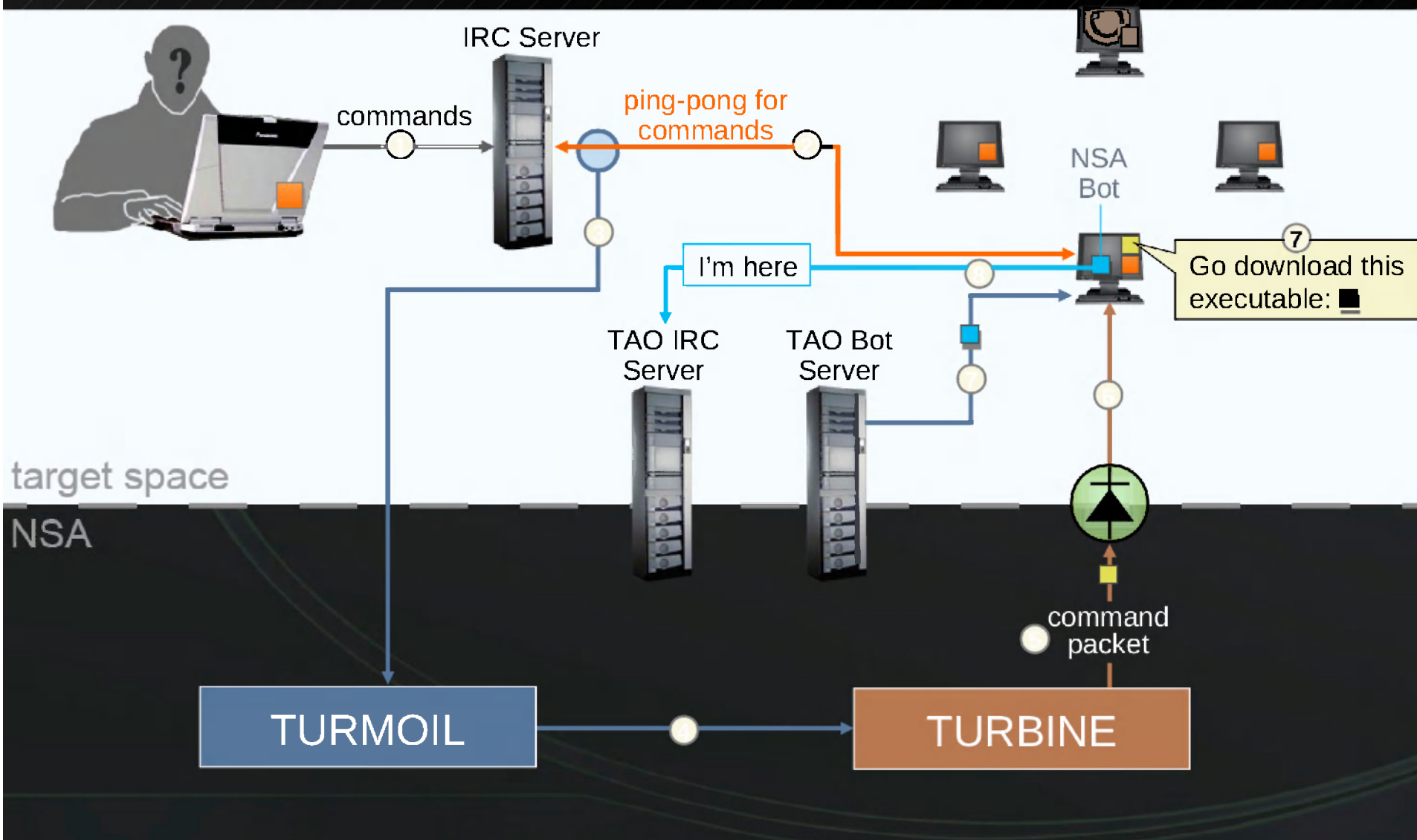

The Reality

- QBOT tipping off of INCENSER
- ... but nowhere else
- Have bots in [redacted] and [redacted]
- ... but nowhere else
- Channel health is highly diurnal

Channel Health

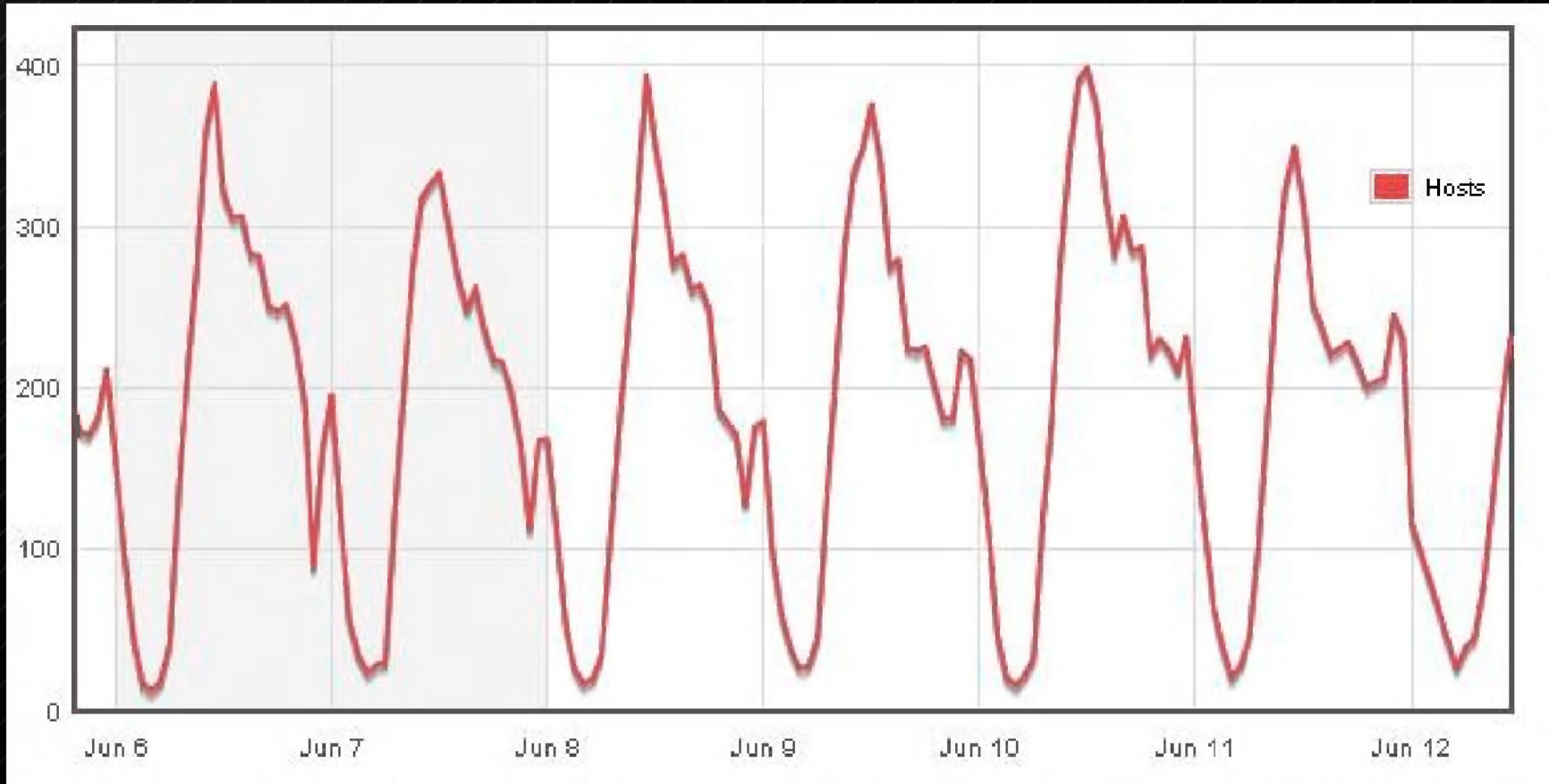

If wishes were ponies...

- A botnet upon which the sun never sets
- QUANTUMBOT tipping diversification
 - STELLABLUE
 - SMOKYSINK
 - TURMOILs at Menwith, MSOC, YRS
- Technique diversification
 - Man In The Middle (vs Man On The Side)
 - More locations
 - easier to exploit HTTP bots (no race condition)
 - Throw exploits from our bots
 - Exploit toe-holds on networks to get better penetration

Cylinders Of Excellence



S T O V E P I P E S

Through extensive coordination, we will build a community of complete incompatibility.

Rube Goldbergian Challenges

- QBOT tasking can* get stale (bots change)
- TURMOIL QBOT tasking can* break
- TURBINE QBOT tasking can* break
- ISLANDTRANSPORT can* break
- QUANTUM Diodes can* break
- Web sniper can* break
- FESTIVWRAPPER can* break
- TURBINE bot tasking can* break
- LPs can* break
- FREEFLOW diodes can* break
- TAO-homed post-processing can* break
- TURBINE-homed post-processing can* break
- Security Marking Service can* break
- PRESSUREWAVE can* break

* do / does

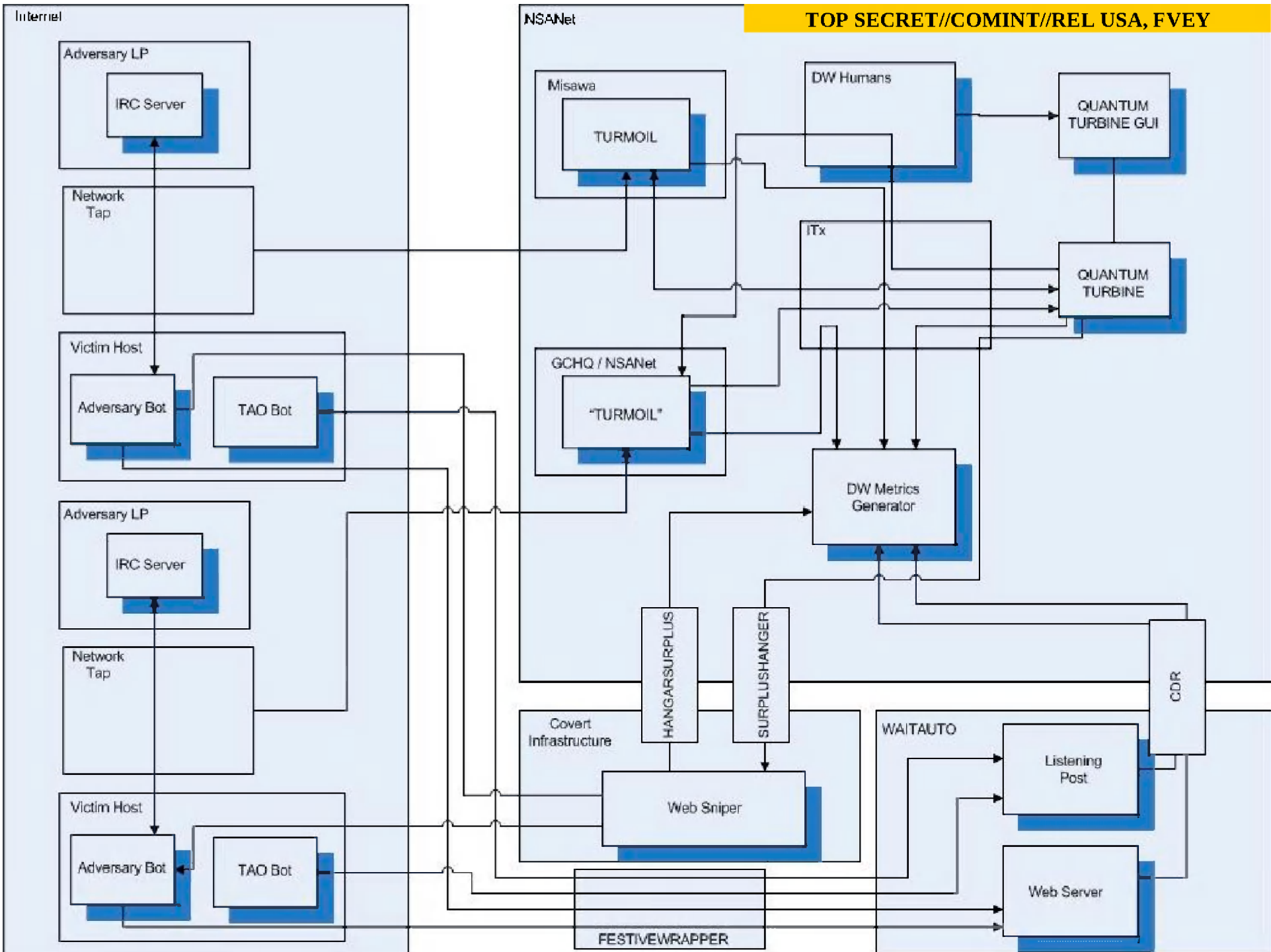

TAO Net

TOP SECRET//COMINT//REL USA, FVEY

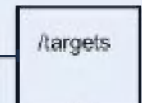
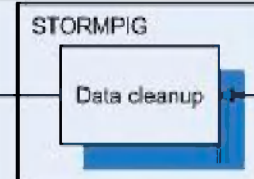
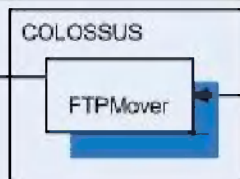

CDR (high)

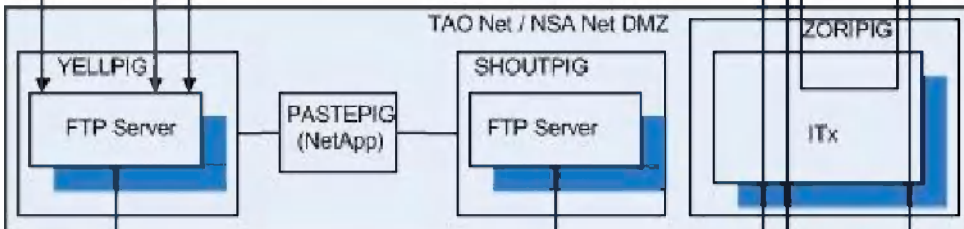
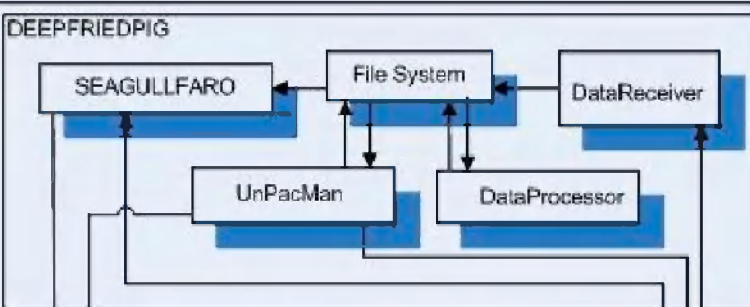
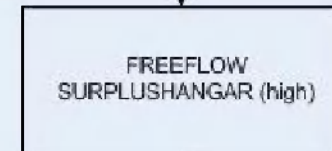
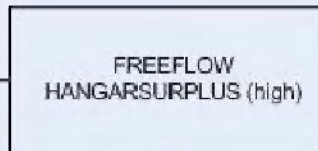

WAITAUTO

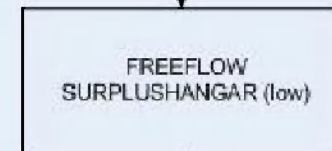
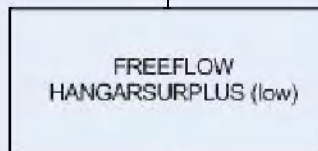

CDR (low)

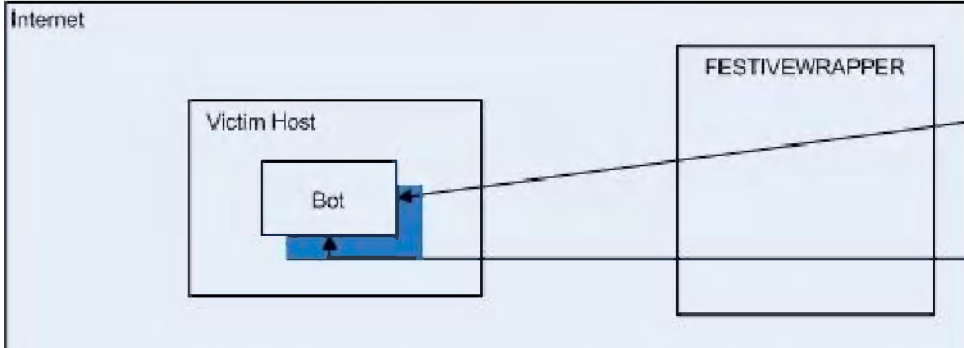
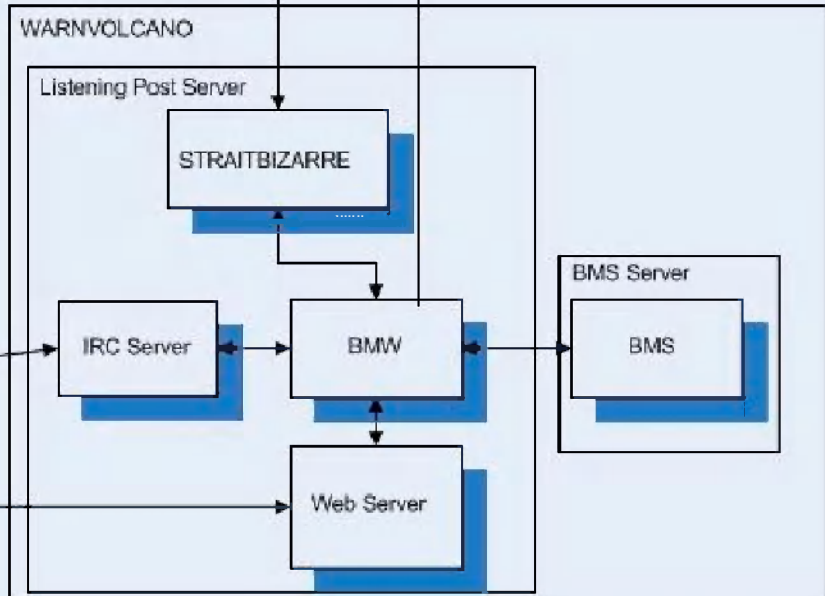
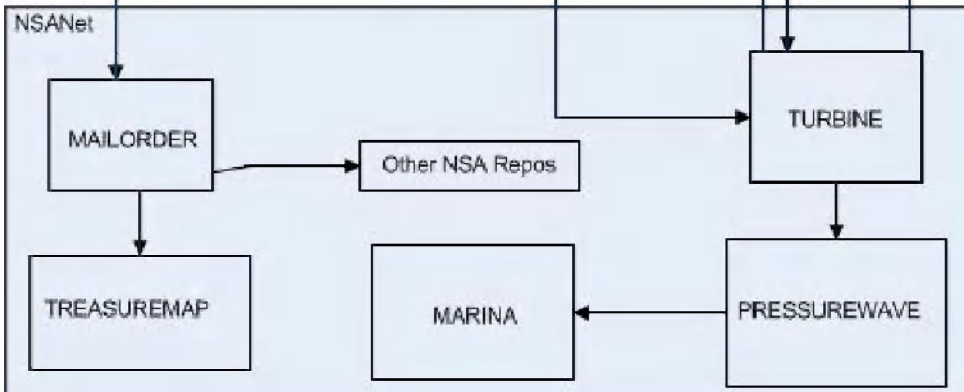
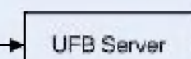
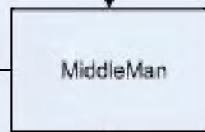

Staying Sane In A Decoupled World

- Glom onto every status feed you can
- Squeeze the possible problem region
- Know who can help you

Metrics, Metrics, and more Metrics

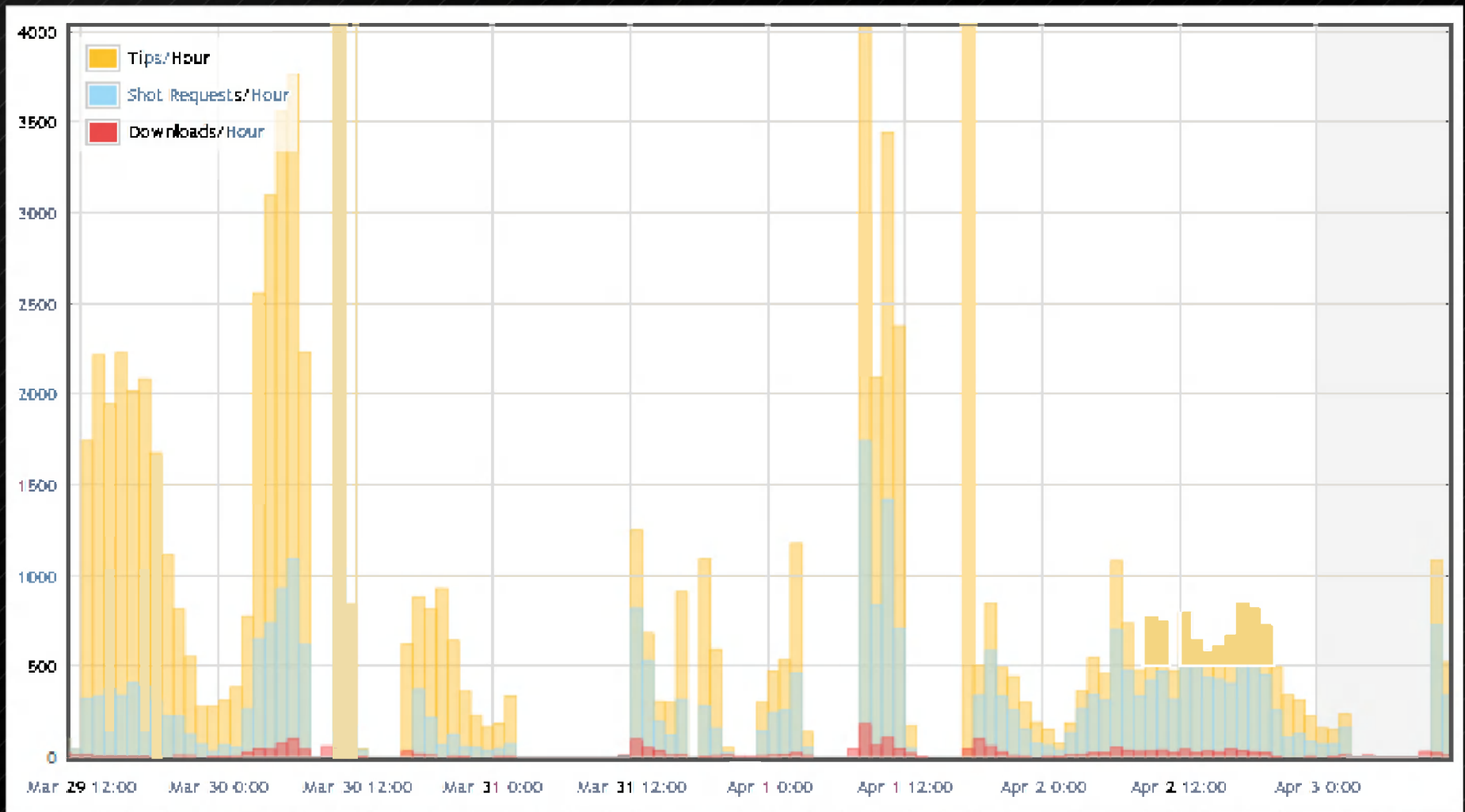

For BotInstances Located In [Redacted] Of Type XTNZ (Connected | [All]) Displaying BotInstances 1 - 30 of 1593 in total

< Previous 1 2 3 4 5 6 7 8 9 ... 53 54 Next >

Per Page: 25 < 50 < 100 < All

	[+]	Bot Instance	Bot Type	Machine	Last Observed IP	First Callback Time	Last Callback Time	Lifetime	Country	Binary Key
1	<input type="checkbox"/>	[XTNZ]-JGIAWOMYMBNTAHVJKIBI	[+] XTNZ	JGIAWOMYMBNTAHVJKIBI	[Redacted]	2010-03-26 19:56:42 UTC	2010-04-21 19:21:03 UTC	26d 5h 24m 21s	[Redacted]	
2	<input type="checkbox"/>	[XTNZ]-AVHTVC CSPJWQDWYWDxB	[+] XTNZ	AVHTVC CSPJWQDWYWDxB	[Redacted]	2010-03-22 07:49:12 UTC	2010-04-21 19:21:03 UTC	30d 11h 31m 48s	[Redacted]	
3	<input type="checkbox"/>	[XTNZ]-XOBJWCQKVEJEMEDGKUNT	[+] XTNZ	XOBJWCQKVEJEMEDGKUNT	[Redacted]	2010-03-18 10:42:13 UTC	2010-04-21 19:20:51 UTC	44d 8h 38m 46s	[Redacted]	
4	<input type="checkbox"/>	[XTNZ]-PDCWHBKVOIGRPPAUZARD	[+] XTNZ	PDCWHBKVOIGRPPAUZARD	[Redacted]	2010-03-10 08:02:17 UTC	2010-04-21 19:20:54 UTC	42d 11h 18m 37s	[Redacted]	
5	<input type="checkbox"/>	[XTNZ]-ZHUWOLY UZHYM*POJBY	[+] XTNZ	ZHUWOLY UZHYM*POJBY	[Redacted]	2010-03-10 13:55:54 UTC	2010-04-21 19:20:54 UTC	42d 5h 25m 13s	[Redacted]	
6	<input type="checkbox"/>	[XTNZ]-YWGCEFULRC JZSWJHFGC	[+] XTNZ	YWGCEFULRC JZSWJHFGC	[Redacted]	2009-11-30 05:15:05 UTC	2010-04-21 19:20:45 UTC	142d 14h 5m 40s	[Redacted]	
7	<input type="checkbox"/>	[XTNZ]-SEELQDFVCGZVOKWYUN	[+] XTNZ	SEELQDFVCGZVOKWYUN	[Redacted]	2010-03-21 16:16:34 UTC	2010-04-21 19:20:29 UTC	31d 3h 3m 55s	[Redacted]	
8	<input type="checkbox"/>	[XTNZ]-INXDMRYRROACSSAADTZR	[+] XTNZ	INXDMRYRROACSSAADTZR	[Redacted]	2010-03-17 10:05:23 UTC	2010-04-21 19:20:28 UTC	35d 0h 14m 0s	[Redacted]	
9	<input type="checkbox"/>	[XTNZ]-HUTANSCBIOGKLCZLXVEA	[+] XTNZ	HUTANSCBIOGKLCZLXVEA	[Redacted]	2010-03-18 06:54:59 UTC	2010-04-21 19:20:28 UTC	34d 12h 25m 26s	[Redacted]	
10	<input type="checkbox"/>	[XTNZ]-MKILDRAENRUXYHWONDMO	[+] XTNZ	MKILDRAENRUXYHWONDMO	[Redacted]	2010-03-21 15:45:32 UTC	2010-04-21 19:20:28 UTC	31d 3h 34m 56s	[Redacted]	
11	<input type="checkbox"/>	[XTNZ]-HOSHJVRPJIWAFCEMSxK	[+] XTNZ	HOSHJVRPJIWAFCEMSxK	[Redacted]	2010-03-21 19:52:13 UTC	2010-04-21 19:20:28 UTC	30d 25h 25m 15s	[Redacted]	
12	<input type="checkbox"/>	[XTNZ]-NCCRFJINMKXJKBIAUCH	[+] XTNZ	NCCRFJINMKXJKBIAUCH	[Redacted]	2010-03-22 10:01:02 UTC	2010-04-21 19:20:28 UTC	30d 0h 17m 25s	[Redacted]	
13	<input type="checkbox"/>	[XTNZ]-EKSHESSIJURPILYTPRDO	[+] XTNZ	EKSHESSIJURPILYTPRDO	[Redacted]	2010-04-01 10:27:41 UTC	2010-04-21 19:20:21 UTC	20d 8h 52m 40s	[Redacted]	
14	<input type="checkbox"/>	[XTNZ]-FFPKLQMBUVEHALIRBSE	[+] XTNZ	FFPKLQMBUVEHALIRBSE	[Redacted]	2010-03-11 11:59:05 UTC	2010-04-21 19:20:17 UTC	41d 7h 21m 12s	[Redacted]	
15	<input type="checkbox"/>	[XTNZ]-LNKWMUQDRJITCRNUPDC	[+] XTNZ	LNKWMUQDRJITCRNUPDC	[Redacted]	2010-03-17 21:07:41 UTC	2010-04-21 19:20:17 UTC	34d 22h 12m 36s	[Redacted]	
16	<input type="checkbox"/>	[XTNZ]-PKCKENROSSxUTSZHTCIN	[+] XTNZ	PKCKENROSSxUTSZHTCIN	[Redacted]	2010-04-01 18:09:15 UTC	2010-04-21 19:20:08 UTC	20d 1h 10m 53s	[Redacted]	
17	<input type="checkbox"/>	[XTNZ]-EVDLNBABLXZHYC3CNxG	[+] XTNZ	EVDLNBABLXZHYC3CNxG	[Redacted]	2010-03-31 13:53:33 UTC	2010-04-21 19:19:47 UTC	21d 5h 26m 14s	[Redacted]	
18	<input type="checkbox"/>	[XTNZ]-EMWNTULXVOLVPCXLAUWH	[+] XTNZ	EMWNTULXVOLVPCXLAUWH	[Redacted]	2010-03-11 09:36:28 UTC	2010-04-21 19:19:36 UTC	41d 9h 43m 8s	[Redacted]	
19	<input type="checkbox"/>	[XTNZ]-HWQWMMYVSHWEAMEJODNA	[+] XTNZ	HWQWMMYVSHWEAMEJODNA	[Redacted]	2010-03-23 09:30:13 UTC	2010-04-21 19:19:21 UTC	29d 9h 49m 8s	[Redacted]	
20	<input type="checkbox"/>	[XTNZ]-QYZYUYPWDOLZIIPPMOOP	[+] XTNZ	QYZYUYPWDOLZIIPPMOOP	[Redacted]	2010-03-23 09:42:21 UTC	2010-04-21 19:19:19 UTC	29d 9h 15m 00s	[Redacted]	
21	<input type="checkbox"/>	[XTNZ]-AGFXNMASRQAVRQIHOFA	[+] XTNZ	AGFXNMASRQAVRQIHOFA	[Redacted]	2010-03-22 06:23:53 UTC	2010-04-21 19:19:07 UTC	30d 12h 55m 17s	[Redacted]	
22	<input type="checkbox"/>	[XTNZ]-MRSQJREKUSMNMUPxWJIO	[+] XTNZ	MRSQJREKUSMNMUPxWJIO	[Redacted]	2010-03-23 09:20:10 UTC	2010-04-21 19:19:07 UTC	29d 0h 47m 57s	[Redacted]	
23	<input type="checkbox"/>	[XTNZ]-QXDTLZVAZUNTYAAQIGW	[+] XTNZ	QXDTLZVAZUNTYAAQIGW	[Redacted]	2010-03-26 13:20:43 UTC	2010-04-21 19:19:07 UTC	26d 5h 57m 19s	[Redacted]	
24	<input type="checkbox"/>	[XTNZ]-QHASZJMBRYMXXKMEYKTA	[+] XTNZ	QHASZJMBRYMXXKMEYKTA	[Redacted]	2010-03-27 01:40:33 UTC	2010-04-21 19:19:01 UTC	25d 17h 32m 26s	[Redacted]	
25	<input type="checkbox"/>	[XTNZ]-FREYHJGEMMWALTYAREZZ	[+] XTNZ	FREYHJGEMMWALTYAREZZ	[Redacted]	2009-11-11 13:00:34 UTC	2010-04-21 19:18:30 UTC	161d 6h 17m 03s	[Redacted]	
26	<input type="checkbox"/>	[XTNZ]-XZABODIONKXIDNOVWLL	[+] XTNZ	XZABODIONKXIDNOVWLL	[Redacted]	2010-04-11 08:53:59 UTC	2010-04-21 19:16:47 UTC	20d 10h 18m 8s	[Redacted]	
27	<input type="checkbox"/>	[XTNZ]-LNLHUONIZGARDOPETHIU	[+] XTNZ	LNLHUONIZGARDOPETHIU	[Redacted]	2010-03-23 04:42:40 UTC	2010-04-21 19:16:23 UTC	29d 14h 33m 40s	[Redacted]	
28	<input type="checkbox"/>	[XTNZ]-BESDIDGLVYLYFTGGFYZC	[+] XTNZ	BESDIDGLVYLYFTGGFYZC	[Redacted]	2010-04-02 09:19:50 UTC	2010-04-21 19:14:29 UTC	19d 9h 54m 39s	[Redacted]	

Walk The Line

- Be awesome enough to be useful...
- ... and not get caught trivially
- ... but not as awesome as a state actor
- ... and notice when we do get burned

Prevent and Detect

- Today
 - Uniquely packed shipped binaries
 - Uniquely keyed shipped binaries
 - Separate LPs
- Tomorrow
 - LPs shielded with commercial services
 - Deployment is carefully staged
 - Reverse honey-nets

Getting Data To Useful Places

- Today
 - Put SIGDEV surveys in PRESSUREWAVE
 - Send traceroutes to TREASUREMAP
- Tomorrow
 - Enrich connect logs with PUZZLECUBE
 - Make bot data visible to MARINA
 - Make file collection possible with SEEKER
 - Put BMS on NSANet
 - Push captured PKI to CES
 - Harvest user identifiers and marry up with other data

A Brief Tour Of The BMS

File Edit View History Bookmarks Tools Help

Most Visited Getting Started Latest Headlines

BotInstances: index BotInstances: show

Threads [Bots] [Connected Bots] [Bot Types] [Machines] [IP Usages] [Countries] [Command Recurrences] [Command Types] Logged in as: 73882

Refresh Every Minute

For BotInstances Unfiltered (Connected | [All])

Displaying BotInstances 1 - 30 of 5940 in total

« Previous 1 2 3 4 5 6 7 8 9 .. 197 198 Next »
Per Page: 25 < 50 < 100 < All

	[+]	Bot Instance	Bot Type	Machine	Last Observed IP	First Callback Time	Last Callback Time ▼	Lifetime	Country	Binary Key
1	<input type="checkbox"/>	[XTNZ]-IVKCOB[NSYEEENCFLCH+M	[+] XTNZ	IVKCOB[NSYEEENCFLCH+M		2010-03-22 06:24:57 UTC	2010-04-21 19:07:25 UTC	30d 12h 42m 28s		
2	<input type="checkbox"/>	[XTNZ]-SESLOOPVICGZVOKWIYUN	[+] XTNZ	SESLOOPVICGZVOKWIYUN		2010-03-21 16:16:34 UTC	2010-04-21 19:07:24 UTC	31d 2h 50m 50s		
3	<input type="checkbox"/>	[XTNZ]-EYD-LNABZLKZHYGBCQVY	[+] XTNZ	EYD-LNABZLKZHYGBCQVY		2010-03-31 13:53:33 UTC	2010-04-21 19:07:14 UTC	21d 5h 13m 41s		
4	<input type="checkbox"/>	[TURD]-NRWVGGPPCADQQM[VV:VZV	[+] TURD	NRWVGGPPCADQQM[VV:VZV		2010-04-01 19:06:10 UTC	2010-04-21 19:07:11 UTC	19d 20h 27m 53s		nrFuu9ucHT ...
5	<input type="checkbox"/>	[XTNZ]-PKOKRNROSSXUTSZHTQJN	[+] XTNZ	PKOKRNROSSXUTSZHTQJN		2010-04-01 18:09:15 UTC	2010-04-21 19:07:10 UTC	20d 0h 57m 55s		
6	<input type="checkbox"/>	[TURD]-DDDWHBKVOICRDP[AUZ+BE	[+] TURD	DDDWHBKVOICRDP[AUZ+BE		2010-03-11 17:01:31 UTC	2010-04-21 19:07:09 UTC	41d 2h 5m 38s		BF7x0D1vCB ...
7	<input type="checkbox"/>	[TURD]-IUCWOTDONOFGUAROSVOX	[+] TURD	IUCWOTDONOFGUAROSVOX		2010-03-24 18:36:31 UTC	2010-04-21 19:07:09 UTC	28d 0h 34m 38s		HcOJE2E5Zh ...
8	<input type="checkbox"/>	[TURD]-CXDILNAZLNIVXASUSW	[+] TURD	CXDILNAZLNIVXASUSW		2010-04-01 13:12:36 UTC	2010-04-21 19:07:09 UTC	20d 5h 54m 33s		Rvnd8n5DL1 ...
9	<input type="checkbox"/>	[TURD]-QVYZLQRMTLQVIGBEUORL	[+] TURD	QVYZLQRMTLQVIGBEUORL		2010-04-16 15:10:04 UTC	2010-04-21 19:07:09 UTC	5d 3h 57m 5s		peoD1ep Int ...
10	<input type="checkbox"/>	[XTNZ]-FMWNTULXVOLVPCXLAUHH	[+] XTNZ	FMWNTULXVOLVPCXLAUHH		2010-03-11 09:36:28 UTC	2010-04-21 19:07:04 UTC	41d 9h 30m 36s		
11	<input type="checkbox"/>	[XTNZ]-MFRDCUMTYKZGLYCRWFEW	[+] XTNZ	MFRDCUMTYKZGLYCRWFEW		2010-03-23 04:43:25 UTC	2010-04-21 19:07:04 UTC	29d 14h 23m 35s		
12	<input type="checkbox"/>	[XTNZ]-JERBPDBEDFLYKOWUJHH	[+] XTNZ	JERBPDBEDFLYKOWUJHH		2010-03-27 13:14:05 UTC	2010-04-21 19:07:04 UTC	25d 5h 52m 53s		
13	<input type="checkbox"/>	[XTNZ]-BDDGGVRAFWWIJHACJQGG	[+] XTNZ	BDDGGVRAFWWIJHACJQGG		2010-03-31 14:22:32 UTC	2010-04-21 19:07:04 UTC	21d 4h 44m 32s		
14	<input type="checkbox"/>	[TURD]-FMWNTULXVOLVPCXLAUHH	[+] TURD	FMWNTULXVOLVPCXLAUHH		2010-03-11 09:47:17 UTC	2010-04-21 19:07:03 UTC	40d 23h 19m 45s		yrXTYEsvE ...
15	<input type="checkbox"/>	[XTNZ]-IUCWOTDONOFGUAROSVOX	[+] XTNZ	IUCWOTDONOFGUAROSVOX		2010-03-22 09:17:55 UTC	2010-04-21 19:06:54 UTC	30d 15h 45m 1s		
16	<input type="checkbox"/>	[XTNZ]-AGEXNMBBQAVGXJHLOPA	[+] XTNZ	AGEXNMBBQAVGXJHLOPA		2010-03-22 00:23:50 UTC	2010-04-21 19:06:54 UTC	30d 12h 43m 4s		
17	<input type="checkbox"/>	[XTNZ]-YZAIHOEDBSQIOZGHHANS	[+] XTNZ	YZAIHOEDBSQIOZGHHANS		2010-03-22 09:51:25 UTC	2010-04-21 19:06:54 UTC	30d 9h 15m 28s		
18	<input type="checkbox"/>	[XTNZ]-MRS6JRZKUSMNMUPXWNJQ	[+] XTNZ	MRS6JRZKUSMNMUPXWNJQ		2010-03-20 09:29:10 UTC	2010-04-21 19:06:54 UTC	29d 9h 37m 44s		
19	<input type="checkbox"/>	[XTNZ]-CXDILNAZLNIVXASUSW	[+] XTNZ	CXDILNAZLNIVXASUSW		2010-03-25 13:21:46 UTC	2010-04-21 19:06:54 UTC	26d 5h 45m 6s		
20	<input type="checkbox"/>	[XTNZ]-GJDFESZHXBYGQIRCBWC	[+] XTNZ	GJDFESZHXBYGQIRCBWC		2010-03-20 08:04:45 UTC	2010-04-21 19:06:54 UTC	22d 11h 2m 11s		
21	<input type="checkbox"/>	[XTNZ]-HOFDDPPYCKFKGDOAHHS	[+] XTNZ	HOFDDPPYCKFKGDOAHHS		2010-03-30 10:46:34 UTC	2010-04-21 19:06:54 UTC	22d 8h 20m 20s		
22	<input type="checkbox"/>	[TURD]-XQBJWCOMVQJEMEDGKUX	[+] TURD	XQBJWCOMVQJEMEDGKUX		2010-03-11 19:47:19 UTC	2010-04-21 19:06:52 UTC	40d 23h 19m 33s		aswfrfmv ...
23	<input type="checkbox"/>	[TURD]-QHTFEJEDWUXFBNDMODQNI	[+] TURD	QHTFEJEDWUXFBNDMODQNI		2010-03-24 15:44:37 UTC	2010-04-21 19:06:52 UTC	20d 3h 22m 15s		9G6VqP2Rq ...
24	<input type="checkbox"/>	[TURD]-IASTIKABAQIDWYNMYSQA	[+] TURD	IASTIKABAQIDWYNMYSQA		2010-03-24 15:44:53 UTC	2010-04-21 19:06:52 UTC	28d 3h 21m 55s		Psi5n70WC ...
25	<input type="checkbox"/>	[TURD]-ALNABRMDZQJGKBUKUDJI	[+] TURD	ALNABRMDZQJGKBUKUDJI		2010-04-01 19:35:29 UTC	2010-04-21 19:06:52 UTC	19d 23h 31m 23s		ESr2BF8A7 ...
26	<input type="checkbox"/>	[TURD]-AGEXNMBBQAVGXJHLOPA	[+] TURD	AGEXNMBBQAVGXJHLOPA		2010-03-24 13:42:48 UTC	2010-04-21 19:06:42 UTC	28d 5h 23m 54s		LqA1958x ...
27	<input type="checkbox"/>	[TURD]-YZAIHOEDBSQIOZGHHANS	[+] TURD	YZAIHOEDBSQIOZGHHANS		2010-03-24 17:48:20 UTC	2010-04-21 19:06:42 UTC	28d 1h 18m 22s		230h22H/f ...
28	<input type="checkbox"/>	[TURD]-ILJWCJYNSTCILDHOWZAQ	[+] TURD	ILJWCJYNSTCILDHOWZAQ		2010-03-24 10:31:20 UTC	2010-04-21 19:06:42 UTC	28d 0h 35m 19s		K3z1DG6mk ...

File Edit View History Bookmarks Tools Help

Most Visited Getting Started Latest Headlines

BotInstances: index BotInstances: show

Threads [Bots] [Connected Bots] [Bot Types] [Machines] [IP Usages] [Countries] [Command Recurrences] [Command Types] Logged In as: 73882

Refresh Every Minute

For BotInstances Unfiltered (Connected | [All]) Displaying BotInstances 1 - 30 of 5940 in total

« Previous 1 2 3 4 5 6 7 8 9 ... 197 198 Next »
 Page: 25 < 50 < 100 < All

	[+]	Bot Instance	Bot Type	Machine	Last Observed IP	First Callback Time	Last Callback Time ▼	Lifetime	Country	Binary Key
1	<input type="checkbox"/>	[XTNZ]-TVKOCRINSVFNCFIOLHXM	<div style="border: 1px solid black; padding: 2px;"> View Bots Of Type View Bots Also Of Type View Type Stats </div>	TVKOCRINSVFNCFIOLHXM		2010-03-22 06:24:57 UTC	2010-04-21 10:07:25 UTC	30d 12h 42m 28s		
2	<input type="checkbox"/>	[XTNZ]-SESLOOPVIGGZVOKWYUN		SESLOOPVIGGZVOKWYUN		2010-03-21 16:16:24 UTC	2010-04-21 19:07:24 UTC	31d 2h 50m 50s		
3	<input type="checkbox"/>	[XTNZ]-EYU=LHAPZLKZHYG3CRYZ		EYU=LHAPZLKZHYG3CRYZ		2010-03-31 13:53:33 UTC	2010-04-21 19:07:14 UTC	21d 5h 13m 41s		
4	<input type="checkbox"/>	[TURD]-NGVWGSPPCADQQMSVIVDW		NGVWGSPPCADQQMSVIVDW		2010-04-01 19:06:10 UTC	2010-04-21 19:07:11 UTC	19d 20h 27m 50s		rvFu9ucHT ...
5	<input type="checkbox"/>	[XTNZ]-PKQKRNRCSXKUTSZHTQJN	[+] XTNZ	PKQKRNRCSXKUTSZHTQJN		2010-04-01 18:09:15 UTC	2010-04-21 19:07:10 UTC	20d 0h 57m 55s		
6	<input type="checkbox"/>	[TURD]-DDWHRKVOICDPAUZABD	[+] TURD	DDWHRKVOICDPAUZABD		2010-03-11 17:01:31 UTC	2010-04-21 19:07:09 UTC	41d 2h 5m 38s		BF7x0D1wCB ...
7	<input type="checkbox"/>	[TURD]-IUCWOTDONOFGUAROSVOX	[+] TURD	IUCWOTDONOFGUAROSVOX		2010-03-24 18:36:31 UTC	2010-04-21 19:07:09 UTC	28d 0h 34m 38s		HcOJE2E5Zh ...
8	<input type="checkbox"/>	[TURD]-CXDTLZNAZJINTYXAOIGW	[+] TURD	CXDTLZNAZJINTYXAOIGW		2010-04-11 13:12:30 UTC	2010-04-21 19:07:09 UTC	20d 5h 54m 33s		Rvnd8n5DL1 ...
9	<input type="checkbox"/>	[TURD]-CVVZLQRMTLQVIGREUORL	[+] TURD	CVVZLQRMTLQVIGREUORL		2010-04-16 15:10:04 UTC	2010-04-21 19:07:09 UTC	5d 0h 57m 5s		peoD1ep Int ...
10	<input type="checkbox"/>	[XTNZ]-FMWNTULXVOLVPCXLAUHH	[+] XTNZ	FMWNTULXVOLVPCXLAUHH		2010-03-11 09:36:28 UTC	2010-04-21 19:07:04 UTC	41d 9h 30m 36s		
11	<input type="checkbox"/>	[XTNZ]-MFRDQUMTYE2GLYCBWFEW	[+] XTNZ	MFRDQUMTYE2GLYCBWFEW		2010-03-23 04:43:29 UTC	2010-04-21 19:07:04 UTC	29d 14h 23m 35s		
12	<input type="checkbox"/>	[XTNZ]-JERRDDBEDPIYKOWDUIHH	[+] XTNZ	JERRDDBEDPIYKOWDUIHH		2010-03-27 13:14:05 UTC	2010-04-21 19:07:04 UTC	25d 5h 52m 55s		
13	<input type="checkbox"/>	[XTNZ]-BDDCGYRAFWWIJHACJQUG	[+] XTNZ	BDDCGYRAFWWIJHACJQUG		2010-03-31 14:22:32 UTC	2010-04-21 19:07:04 UTC	21d 4h 44m 32s		
14	<input type="checkbox"/>	[TURD]-FMWNTULXVOLVPCXLAUHH	[+] TURD	FMWNTULXVOLVPCXLAUHH		2010-03-11 19:47:17 UTC	2010-04-21 19:07:03 UTC	40d 23h 19m 45s		yrXTYEsvE ...
15	<input type="checkbox"/>	[XTNZ]-IUCWOTDONOFGUAROSVOX	[+] XTNZ	IUCWOTDONOFGUAROSVOX		2010-03-22 09:17:55 UTC	2010-04-21 19:06:54 UTC	30d 15h 49m 1s		
16	<input type="checkbox"/>	[XTNZ]-AGEXNMBRBOAVGXJHLOPA	[+] XTNZ	AGEXNMBRBOAVGXJHLOPA		2010-03-22 06:23:50 UTC	2010-04-21 19:06:54 UTC	30d 12h 43m 4s		
17	<input type="checkbox"/>	[XTNZ]-YZAIHOEDBSOIQZGHHANS	[+] XTNZ	YZAIHOEDBSOIQZGHHANS		2010-03-22 09:51:26 UTC	2010-04-21 19:06:54 UTC	30d 9h 15m 28s		
18	<input type="checkbox"/>	[XTNZ]-MRS6JZKXUSMNMUPXWNJQ	[+] XTNZ	MRS6JZKXUSMNMUPXWNJQ		2010-03-23 09:29:10 UTC	2010-04-21 19:06:54 UTC	29d 9h 37m 44s		
19	<input type="checkbox"/>	[XTNZ]-CXDTLZNAZJINTYXAOIGW	[+] XTNZ	CXDTLZNAZJINTYXAOIGW		2010-03-25 13:21:46 UTC	2010-04-21 19:06:54 UTC	26d 5h 45m 6s		
20	<input type="checkbox"/>	[XTNZ]-GJDPFSZHXIBYGOIRCBXC	[+] XTNZ	GJDPFSZHXIBYGOIRCBXC		2010-03-20 08:24:45 UTC	2010-04-21 19:06:54 UTC	22d 11h 2m 11s		
21	<input type="checkbox"/>	[XTNZ]-HOFDDPPYCKFKGDOAHHS	[+] XTNZ	HOFDDPPYCKFKGDOAHHS		2010-03-20 10:40:34 UTC	2010-04-21 19:06:54 UTC	22d 8h 20m 20s		
22	<input type="checkbox"/>	[TURD]-XORLWOCNEVJEMFNCKIXT	[+] TURD	XORLWOCNEVJEMFNCKIXT		2010-03-11 19:44:15 UTC	2010-04-21 19:06:52 UTC	40d 23h 19m 33s		aswfrfmv ...
23	<input type="checkbox"/>	[TURD]-QHTFEJEDWUXFBNDMODOJN	[+] TURD	QHTFEJEDWUXFBNDMODOJN		2010-03-24 15:44:37 UTC	2010-04-21 19:06:52 UTC	28d 3h 22m 15s		9G6VqR2Rq ...
24	<input type="checkbox"/>	[TURD]-IaSTTKaPaCIDWYNMYSca	[+] TURD	IaSTTKaPaCIDWYNMYSca		2010-03-24 15:44:53 UTC	2010-04-21 19:06:52 UTC	28d 3h 21m 59s		Psi5n70WC ...
25	<input type="checkbox"/>	[TURD]-ALNABRMDZQJGKBKURDJI	[+] TURD	ALNABRMDZQJGKBKURDJI		2010-04-01 19:35:29 UTC	2010-04-21 19:06:52 UTC	19d 23h 51m 23s		ESr2J6F8A? ...
26	<input type="checkbox"/>	[TURD]-AGEXNMBRBOAVGXJHLOPA	[+] TURD	AGEXNMBRBOAVGXJHLOPA		2010-03-24 13:42:48 UTC	2010-04-21 19:06:42 UTC	28d 5h 23m 54s		LqAl958x ...
27	<input type="checkbox"/>	[TURD]-YZAIHOEDBSOIQZGHHANS	[+] TURD	YZAIHOEDBSOIQZGHHANS		2010-03-24 17:48:20 UTC	2010-04-21 19:06:42 UTC	28d 1h 18m 22s		230kz2E/f ...
28	<input type="checkbox"/>	[TURD]-ILJWCJYNSTGILDHGWZAQ	[+] TURD	ILJWCJYNSTGILDHGWZAQ		2010-03-24 10:31:20 UTC	2010-04-21 19:06:42 UTC	28d 0h 35m 19s		K3z1DGfOmK ...

File Edit View History Bookmarks Tools Help

Most Visited Getting Started Latest Headlines

BotInstances: index BotInstances: show

Threads [Bots] [Connected Bots] [Bot Types] [Machines] [IP Usages] [Countries] [Command Recurrences] [Command Types] Logged in as: 73882

Refresh Every Minute

For BotInstances Of Type XTNZ (Connected | [All]) Displaying BotInstances 1 - 30 of 3556 in total

« Previous 1 2 3 4 5 6 7 8 9 ... 118 119 Next »
Per Page: 25 < 50 < 100 < All

	[+]	Bot Instance	Bot Type	Machine	Last Observed IP	First Callback Time	Last Callback Time ▼	Uptime	Country	Binary Key
1	<input type="checkbox"/>	[XTNZ]-AVHTNOCSPJWQDWYWDXB	[+] XTNZ	AVHTNOCSPJWQDWYWDXB		2010-03-22 07:49:12 UTC	2010-04-21 19:19:21 UTC	30d 11h 30m 9s		
2	<input type="checkbox"/>	[XTNZ]-HWOWMYVSHWEAMEJQDNA	[+] XTNZ	HWOWMYVSHWEAMEJQDNA		2010-03-23 09:33:13 UTC	2010-04-21 19:19:21 UTC	29d 9h 49m 8s		
3	<input type="checkbox"/>	[XTNZ]-DYZUYJWDOLZTPPMOOP	[+] XTNZ	DYZUYJWDOLZTPPMOOP		2010-03-23 09:42:21 UTC	2010-04-21 19:19:19 UTC	29d 9h 36m 58s		
4	<input type="checkbox"/>	[XTNZ]-IUCWQTDONQFGUAROSVOX	[+] XTNZ	IUCWQTDONQFGUAROSVOX		2010-03-22 09:17:53 UTC	2010-04-21 19:19:07 UTC	30d 16h 1m 14s		
5	<input type="checkbox"/>	[XTNZ]-AGEXNM3SBCAVGKJH_OFA	[+] XTNZ	AGEXNM3SBCAVGKJH_OFA		2010-03-22 06:23:50 UTC	2010-04-21 19:19:07 UTC	30d 12h 55m 17s		
6	<input type="checkbox"/>	[XTNZ]-VZAIHQEDBSOIGZC-HANS	[+] XTNZ	VZAIHQEDBSOIGZC-HANS		2010-03-22 09:51:25 UTC	2010-04-21 19:19:07 UTC	30d 9h 27m 41s		
7	<input type="checkbox"/>	[XTNZ]-MBSGJZKUSMNMUPKWNIO	[+] XTNZ	MBSGJZKUSMNMUPKWNIO		2010-03-23 09:29:10 UTC	2010-04-21 19:19:07 UTC	29d 9h 49m 57s		
8	<input type="checkbox"/>	[XTNZ]-CRDILZNAZJINTVXAOIGW	[+] XTNZ	CRDILZNAZJINTVXAOIGW		2010-03-26 13:21:43 UTC	2010-04-21 19:19:07 UTC	26d 5h 57m 19s		
9	<input type="checkbox"/>	[XTNZ]-HOFDPPYCKFKGQD4HHS	[+] XTNZ	HOFDPPYCKFKGQD4HHS		2010-03-30 10:46:34 UTC	2010-04-21 19:19:07 UTC	22d 8h 32m 33s		
10	<input type="checkbox"/>	[XTNZ]-OHASZIMBRYMWXKMFYKTA	[+] XTNZ	OHASZIMBRYMWXKMFYKTA		2010-03-27 01:45:33 UTC	2010-04-21 19:19:01 UTC	25d 17h 32m 26s		
11	<input type="checkbox"/>	[XTNZ]-ZPINCPRGUCIKOZB3CDTH	[+] XTNZ	ZPINCPRGUCIKOZB3CDTH		2010-03-30 21:07:09 UTC	2010-04-21 19:18:54 UTC	21d 22h 11m 45s		
12	<input type="checkbox"/>	[XTNZ]-KOBJWCOKEVJEMEDGKUXI	[+] XTNZ	KOBJWCOKEVJEMEDGKUXI		2010-03-08 10:42:08 UTC	2010-04-21 19:18:48 UTC	44d 8h 25m 43s		
13	<input type="checkbox"/>	[XTNZ]-PDDWHBKVYDGRPPAUZABD	[+] XTNZ	PDDWHBKVYDGRPPAUZABD		2010-03-10 00:02:17 UTC	2010-04-21 19:18:40 UTC	42d 11h 16m 31s		
14	<input type="checkbox"/>	[XTNZ]-XHUWQDYTIIZHYMYPQJRM	[+] XTNZ	XHUWQDYTIIZHYMYPQJRM		2010-03-10 13:55:54 UTC	2010-04-21 19:18:48 UTC	42d 5h 22m 54s		
15	<input type="checkbox"/>	[XTNZ]-DGBQJWGTUBJNCQVEXORL	[+] XTNZ	DGBQJWGTUBJNCQVEXORL		2010-03-22 00:37:13 UTC	2010-04-21 19:18:43 UTC	30d 10h 41m 35s		
16	<input type="checkbox"/>	[XTNZ]-OHTFJEDWUXFBNDMUDUNI	[+] XTNZ	OHTFJEDWUXFBNDMUDUNI		2010-03-23 04:44:10 UTC	2010-04-21 19:18:43 UTC	29d 14h 34m 38s		
17	<input type="checkbox"/>	[XTNZ]-DFZUNZVKKOHZAQIXFHU	[+] XTNZ	DFZUNZVKKOHZAQIXFHU		2010-03-31 13:04:41 UTC	2010-04-21 19:18:43 UTC	21d 6h 14m 7s		
18	<input type="checkbox"/>	[XTNZ]-YWGLEFULROUZSWJIFOC	[+] XTNZ	YWGLEFULROUZSWJIFOC		2009-11-30 05:15:05 UTC	2010-04-21 19:18:40 UTC	142d 14h 3m 35s		
19	<input type="checkbox"/>	[XTNZ]-FRFXIGMELMWTYAREZZ	[+] XTNZ	FRFXIGMELMWTYAREZZ		2009-11-11 13:00:34 UTC	2010-04-21 19:18:30 UTC	161d 6h 17m 56s		
20	<input type="checkbox"/>	[XTNZ]-ALNARMDZQJOKBUEDJ	[+] XTNZ	ALNARMDZQJOKBUEDJ		2010-04-01 19:11:10 UTC	2010-04-21 19:18:30 UTC	20d 0h 7m 11s		
21	<input type="checkbox"/>	[XTNZ]-NGVWGEPEQADQOMS+VVDW	[+] XTNZ	NGVWGEPEQADQOMS+VVDW		2010-03-29 10:25:28 UTC	2010-04-21 19:18:29 UTC	23d 8h 53m 1s		
22	<input type="checkbox"/>	[XTNZ]-CTVEMNPOOQOOLSYZSUTJ	[+] XTNZ	CTVEMNPOOQOOLSYZSUTJ		2009-12-31 15:04:12 UTC	2010-04-21 19:18:21 UTC	141d 4h 14m 9s		
23	<input type="checkbox"/>	[XTNZ]-INYDMRYRQACSSBBDTZP	[+] XTNZ	INYDMRYRQACSSBBDTZP		2010-03-17 19:06:28 UTC	2010-04-21 19:18:21 UTC	35d 0h 11m 53s		
24	<input type="checkbox"/>	[XTNZ]-HUTANSPIORQ_CZ_XVFA	[+] XTNZ	HUTANSPIORQ_CZ_XVFA		2010-03-18 06:54:59 UTC	2010-04-21 19:18:21 UTC	34d 12h 23m 22s		
25	<input type="checkbox"/>	[XTNZ]-MKTLDPAENRUXVHWONDMO	[+] XTNZ	MKTLDPAENRUXVHWONDMO		2010-03-21 15:45:32 UTC	2010-04-21 19:18:21 UTC	31d 3h 53m 40s		
26	<input type="checkbox"/>	[XTNZ]-HUSHJBVRPJWBNFCEMSXK	[+] XTNZ	HUSHJBVRPJWBNFCEMSXK		2010-03-21 19:52:13 UTC	2010-04-21 19:18:21 UTC	30d 23h 26m 8s		
27	<input type="checkbox"/>	[XTNZ]-PMINPROBLESAQA+WYDN	[+] XTNZ	PMINPROBLESAQA+WYDN		2010-03-22 07:29:35 UTC	2010-04-21 19:18:21 UTC	30d 11h 48m 45s		
28	<input type="checkbox"/>	[XTNZ]-NCCRJFINMKUXIBIAUCH	[+] XTNZ	NCCRJFINMKUXIBIAUCH		2010-03-22 10:01:02 UTC	2010-04-21 19:18:21 UTC	30d 9h 17m 19s		

File Edit View History Bookmarks Tools Help

Most Visited Getting Started Latest Headlines

BotInstances: index BotInstances: show

Threads [Bots] [Connected Bots] [Bot Types] [Machines] [IP Usages] [Countries] [Command Recurrences] [Command Types] Logged in as: 79882

Refresh Every Minute

For BotInstances Of Type XTNZ (Connected | [All])

Displaying BotInstances 1 - 30 of 3556 in total

« Previous 1 2 3 4 5 6 7 8 9 ... 118 119 Next »
 Per Page: 25 < 50 < 100 < All

	[+]	Bot Instance	Bot Type	Machine	Last Observed IP	First Callback Time	Last Callback Time ▼	Lifetime	Country	Binary Key
1	<input type="checkbox"/>	[XTNZ]-AVHTACCSBJWODWVWYWDAB	[+] XTNZ	AVHTACCSBJWODWVWYWDAB		2010-03-22 07:49:12 UTC	2010-04-21 19:10:21 UTC	30d 11h 30m 9s	<div style="display: flex; justify-content: space-around; padding: 5px;"> View Bots In Country </div> <div style="display: flex; justify-content: space-around; padding: 5px;"> View Bots Also In Country </div> <div style="display: flex; justify-content: space-around; padding: 5px;"> View Country Stats </div>	
2	<input type="checkbox"/>	[XTNZ]-HWOWMYVSHWEAMEIQDNA	[+] XTNZ	HWOWMYVSHWEAMEIQDNA		2010-03-23 09:30:13 UTC	2010-04-21 19:19:21 UTC	29d 9h 49m 8s		
3	<input type="checkbox"/>	[XTNZ]-DYZUYAWDOLZTPPMOOP	[+] XTNZ	DYZUYAWDOLZTPPMOOP		2010-03-23 09:42:21 UTC	2010-04-21 19:19:19 UTC	29d 9h 36m 58s		
4	<input type="checkbox"/>	[XTNZ]-IUCWQTDONQFGUAROSVOX	[+] XTNZ	IUCWQTDONQFGUAROSVOX		2010-03-22 03:17:53 UTC	2010-04-21 19:19:07 UTC	30d 16h 1m 14s		
5	<input type="checkbox"/>	[XTNZ]-AGEXNMB3BCAVG3JHLOPA	[+] XTNZ	AGEXNMB3BCAVG3JHLOPA		2010-03-22 06:23:50 UTC	2010-04-21 19:19:07 UTC	30d 12h 55m 17s		
6	<input type="checkbox"/>	[XTNZ]-VZAIHQEDBSOIGZC4HANS	[+] XTNZ	VZAIHQEDBSOIGZC4HANS		2010-03-22 09:51:26 UTC	2010-04-21 19:19:07 UTC	30d 9h 27m 41s		
7	<input type="checkbox"/>	[XTNZ]-MBSGJRZKUSMNMUPKWNIO	[+] XTNZ	MBSGJRZKUSMNMUPKWNIO		2010-03-23 09:29:10 UTC	2010-04-21 19:19:07 UTC	29d 9h 49m 57s		
8	<input type="checkbox"/>	[XTNZ]-CRDILZNAZJINTVXAOIGW	[+] XTNZ	CRDILZNAZJINTVXAOIGW		2010-03-26 13:21:13 UTC	2010-04-21 19:19:07 UTC	26d 5h 57m 19s		
9	<input type="checkbox"/>	[XTNZ]-HOFDDPFYCKFKRQDGAHHS	[+] XTNZ	HOFDDPFYCKFKRQDGAHHS		2010-03-30 10:46:34 UTC	2010-04-21 19:19:07 UTC	22d 8h 32m 33s		
10	<input type="checkbox"/>	[XTNZ]-OHASZIMBRYMXXKMFYKTA	[+] XTNZ	OHASZIMBRYMXXKMFYKTA		2010-03-27 01:45:33 UTC	2010-04-21 19:19:01 UTC	25d 17h 32m 26s		
11	<input type="checkbox"/>	[XTNZ]-ZPINCPRGLQJKQB3CDTH	[+] XTNZ	ZPINCPRGLQJKQB3CDTH		2010-03-30 21:07:09 UTC	2010-04-21 19:18:54 UTC	21d 22h 11m 45s		
12	<input type="checkbox"/>	[XTNZ]-KOBJWCORZVJEMEDGKUXI	[+] XTNZ	KOBJWCORZVJEMEDGKUXI		2010-03-18 10:42:13 UTC	2010-04-21 19:18:48 UTC	44d 8h 35m 43s		
13	<input type="checkbox"/>	[XTNZ]-PDDWHBKVOIGRPPAUZABD	[+] XTNZ	PDDWHBKVOIGRPPAUZABD		2010-03-10 08:02:17 UTC	2010-04-21 19:18:43 UTC	42d 11h 16m 31s		
14	<input type="checkbox"/>	[XTNZ]-XHUWQDYTIIZHYMYPQJRM	[+] XTNZ	XHUWQDYTIIZHYMYPQJRM		2010-03-10 13:55:54 UTC	2010-04-21 19:18:48 UTC	42d 5h 22m 54s		
15	<input type="checkbox"/>	[XTNZ]-DGBQJWGTUBJNCQVEXORL	[+] XTNZ	DGBQJWGTUBJNCQVEXORL		2010-03-22 08:37:13 UTC	2010-04-21 19:18:43 UTC	30d 10h 41m 35s		
16	<input type="checkbox"/>	[XTNZ]-OHTFJEDWUXFBNDMDDONI	[+] XTNZ	OHTFJEDWUXFBNDMDDONI		2010-03-23 04:44:10 UTC	2010-04-21 19:18:43 UTC	29d 14h 34m 38s		
17	<input type="checkbox"/>	[XTNZ]-DFZUNZVJKQHZACJRHUJ	[+] XTNZ	DFZUNZVJKQHZACJRHUJ		2010-03-31 13:04:41 UTC	2010-04-21 19:18:48 UTC	21d 6h 14m 7s		
18	<input type="checkbox"/>	[XTNZ]-YWGCEFULROUZSWJIFOC	[+] XTNZ	YWGCEFULROUZSWJIFOC		2009-11-30 05:15:05 UTC	2010-04-21 19:18:40 UTC	142d 14h 3m 35s		
19	<input type="checkbox"/>	[XTNZ]-FRFXHIGMEMIWAITYAREZZ	[+] XTNZ	FRFXHIGMEMIWAITYAREZZ		2009-11-11 13:00:34 UTC	2010-04-21 19:18:30 UTC	161d 6h 17m 56s		
20	<input type="checkbox"/>	[XTNZ]-ALNABRMDZQJQBKUEDCJ	[+] XTNZ	ALNABRMDZQJQBKUEDCJ		2010-04-31 10:11:10 UTC	2010-04-21 19:18:30 UTC	20d 0h 7m 11s		
21	<input type="checkbox"/>	[XTNZ]-NGVWGSPPGADQOMSVVDW	[+] XTNZ	NGVWGSPPGADQOMSVVDW		2010-03-29 10:25:28 UTC	2010-04-21 19:18:29 UTC	23d 8h 53m 1s		
22	<input type="checkbox"/>	[XTNZ]-CTVEMNPOOOOLSYZSUTJ	[+] XTNZ	CTVEMNPOOOOLSYZSUTJ		2009-12-01 15:04:12 UTC	2010-04-21 19:18:21 UTC	141d 4h 14m 9s		
23	<input type="checkbox"/>	[XTNZ]-INYDMRYRROACSSBBDTZP	[+] XTNZ	INYDMRYRROACSSBBDTZP		2010-04-17 19:06:28 UTC	2010-04-21 19:18:21 UTC	35d 0h 11m 11s		
24	<input type="checkbox"/>	[XTNZ]-HUTAASCPHQKICZ_XVFA	[+] XTNZ	HUTAASCPHQKICZ_XVFA		2010-03-18 06:54:59 UTC	2010-04-21 19:18:21 UTC	34d 12h 23m 22s		
25	<input type="checkbox"/>	[XTNZ]-MKTLDPAENRIBXVHWONDMO	[+] XTNZ	MKTLDPAENRIBXVHWONDMO		2010-03-21 15:45:32 UTC	2010-04-21 19:18:21 UTC	31d 3h 53m 40s		
26	<input type="checkbox"/>	[XTNZ]-HUSHJBVRPJWBNFCEMSXK	[+] XTNZ	HUSHJBVRPJWBNFCEMSXK		2010-03-21 19:52:13 UTC	2010-04-21 19:18:21 UTC	30d 23h 26m 8s		
27	<input type="checkbox"/>	[XTNZ]-PMINPROBLESAQA0WYDN	[+] XTNZ	PMINPROBLESAQA0WYDN		2010-03-22 07:29:36 UTC	2010-04-21 19:18:21 UTC	30d 11h 48m 45s		
28	<input type="checkbox"/>	[XTNZ]-NCCRFJINMKUXJBAUHC	[+] XTNZ	NCCRFJINMKUXJBAUHC		2010-03-22 10:01:02 UTC	2010-04-21 19:18:21 UTC	30d 9h 17m 19s		

File Edit View History Bookmarks Tools Help

Most Visited Getting Started Latest Headlines

BotInstances: index BotInstances: show

Headers [Bots] [Connected Bots] [Bot Types] [Machines] [IP Usages] [Countries] [Command Recurrences] [Command Types] Logged in as: 73882

Refresh Every Minute

For BotInstances Located In [REDACTED] Of Type XTNZ (Connected | [All]) Displaying BotInstances 1 - 30 of 1593 in total

< Previous 1 2 3 4 5 6 7 8 9 ... 53 54 Next >
Per Page: 25 < 50 < 100 < All

	[+]	Bot Instance	Bot Type	Machine	Last Observed IP	First Callback Time	Last Callback Time ▼	Lifetime	Country	Binary Key
1	<input type="checkbox"/>	[XTNZ]-JCIeWChMYMBNIAHwKIBJ	[+] XTNZ	JCIeWChMYMBNIAHwKIBJ	[REDACTED]	2010-03-26 13:56:42 UTC	2010-04-21 19:21:03 UTC	26d 5h 24m 21s	[REDACTED]	
2	<input type="checkbox"/>	[XTNZ]-AVHTNOCSPJWODWWYWDxB	[+] XTNZ	AVHTNOCSPJWODWWYWDxB	[REDACTED]	2010-03-22 07:49:12 UTC	2010-04-21 19:21:00 UTC	30d 11h 31m 45s	[REDACTED]	
3	<input type="checkbox"/>	[XTNZ]-XQBjWCOk-wJH-MEDGKUXL	[+] XTNZ	XQBjWCOk-wJH-MEDGKUXL	[REDACTED]	2010-03-08 10:42:13 UTC	2010-04-21 19:20:54 UTC	44d 8h 38m 46s	[REDACTED]	
4	<input type="checkbox"/>	[XTNZ]-PDDWHRKVOIGRPpAUZABD	[+] XTNZ	PDDWHRKVOIGRPpAUZABD	[REDACTED]	2010-03-10 08:02:17 UTC	2010-04-21 19:20:54 UTC	42d 11h 18m 37s	[REDACTED]	
5	<input type="checkbox"/>	[XTNZ]-XHXWODYTIIZHYMYPOJRM	[+] XTNZ	XHXWODYTIIZHYMYPOJRM	[REDACTED]	2010-03-10 13:55:54 UTC	2010-04-21 19:20:54 UTC	42d 5h 25m 0s	[REDACTED]	
6	<input type="checkbox"/>	[XTNZ]-YWQCFULRCJZSWJIFGC	[+] XTNZ	YWQCFULRCJZSWJIFGC	[REDACTED]	2009-11-30 05:15:05 UTC	2010-04-21 19:20:45 UTC	142d 14h 5m 40s	[REDACTED]	
7	<input type="checkbox"/>	[XTNZ]-SESLOOPVICGZYOKWYUN	[+] XTNZ	SESLOOPVICGZYOKWYUN	[REDACTED]	2010-03-21 16:13:34 UTC	2010-04-21 19:20:29 UTC	31d 3h 5m 55s	[REDACTED]	
8	<input type="checkbox"/>	[XTNZ]-INyJMKYRROACSSBBDTZP	[+] XTNZ	INyJMKYRROACSSBBDTZP	[REDACTED]	2010-03-17 19:06:28 UTC	2010-04-21 19:20:28 UTC	35d 0h 14m 1s	[REDACTED]	
9	<input type="checkbox"/>	[XTNZ]-HUTANSRTOGKI CZI XVEA	[+] XTNZ	HUTANSRTOGKI CZI XVEA	[REDACTED]	2010-03-18 06:54:59 UTC	2010-04-21 19:20:28 UTC	34d 12h 25m 29s	[REDACTED]	
10	<input type="checkbox"/>	[XTNZ]-MKLDRAENRUXY-HWQXDMQ	[+] XTNZ	MKLDRAENRUXY-HWQXDMQ	[REDACTED]	2010-03-21 15:45:32 UTC	2010-04-21 19:20:28 UTC	31d 3h 34m 56s	[REDACTED]	
11	<input type="checkbox"/>	[XTNZ]-HOSHJVRPjWBNECEMSxK	[+] XTNZ	HOSHJVRPjWBNECEMSxK	[REDACTED]	2010-03-21 19:52:13 UTC	2010-04-21 19:20:23 UTC	30d 23h 28m 15s	[REDACTED]	
12	<input type="checkbox"/>	[XTNZ]-NOCRUF...NMxJXJBIAUCh	[+] XTNZ	NOCRUF...NMxJXJBIAUCh	[REDACTED]	2010-03-22 10:01:02 UTC	2010-04-21 19:20:28 UTC	30d 9h 19m 25s	[REDACTED]	
13	<input type="checkbox"/>	[XTNZ]-EKSHESSJURPILYTPBDQ	[+] XTNZ	EKSHESSJURPILYTPBDQ	[REDACTED]	2010-04-01 10:27:41 UTC	2010-04-21 19:20:21 UTC	20d 0h 52m 40s	[REDACTED]	
14	<input type="checkbox"/>	[XTNZ]-FFCKTIOMBUVFHALTRRBC	[+] XTNZ	FFCKTIOMBUVFHALTRRBC	[REDACTED]	2010-03-11 11:59:04 UTC	2010-04-21 19:20:17 UTC	41d 7h 21m 12s	[REDACTED]	
15	<input type="checkbox"/>	[XTNZ]-LNKWMUQJDRBIFERNJPEC	[+] XTNZ	LNKWMUQJDRBIFERNJPEC	[REDACTED]	2010-03-17 21:07:41 UTC	2010-04-21 19:20:17 UTC	34d 22h 12m 36s	[REDACTED]	
16	<input type="checkbox"/>	[XTNZ]-PKCKRNROSSxUTSZHTQJN	[+] XTNZ	PKCKRNROSSxUTSZHTQJN	[REDACTED]	2010-04-01 18:09:15 UTC	2010-04-21 19:20:08 UTC	20d 1h 10m 53s	[REDACTED]	
17	<input type="checkbox"/>	[XTNZ]-EVDENARZLXZHYGRCNYG	[+] XTNZ	EVDENARZLXZHYGRCNYG	[REDACTED]	2010-03-31 13:53:33 UTC	2010-04-21 19:19:47 UTC	21d 5h 26m 14s	[REDACTED]	
18	<input type="checkbox"/>	[XTNZ]-FMWNTULXVQLVPCXLAUJH	[+] XTNZ	FMWNTULXVQLVPCXLAUJH	[REDACTED]	2010-04-11 09:36:28 UTC	2010-04-21 19:19:35 UTC	41d 9h 43m 8s	[REDACTED]	
19	<input type="checkbox"/>	[XTNZ]-HWQWMYVSHWEAMEJODNA	[+] XTNZ	HWQWMYVSHWEAMEJODNA	[REDACTED]	2010-03-23 09:30:13 UTC	2010-04-21 19:19:21 UTC	29d 9h 49m 8s	[REDACTED]	
20	<input type="checkbox"/>	[XTNZ]-QYZYUYjWDOLZiIPPHOOG	[+] XTNZ	QYZYUYjWDOLZiIPPHOOG	[REDACTED]	2010-03-23 09:42:21 UTC	2010-04-21 19:19:19 UTC	29d 0h 35m 53s	[REDACTED]	
21	<input type="checkbox"/>	[XTNZ]-AGEXNMB5BQAVGXJHLOPA	[+] XTNZ	AGEXNMB5BQAVGXJHLOPA	[REDACTED]	2010-03-22 06:23:50 UTC	2010-04-21 19:19:07 UTC	30d 12h 55m 17s	[REDACTED]	
22	<input type="checkbox"/>	[XTNZ]-MRSGJRZxUSyNMUPxwV1O	[+] XTNZ	MRSGJRZxUSyNMUPxwV1O	[REDACTED]	2010-03-23 09:29:10 UTC	2010-04-21 19:19:07 UTC	29d 9h 49m 57s	[REDACTED]	
23	<input type="checkbox"/>	[XTNZ]-CXDTLZNAZJNTVXAQJGW	[+] XTNZ	CXDTLZNAZJNTVXAQJGW	[REDACTED]	2010-03-26 13:21:48 UTC	2010-04-21 19:19:07 UTC	26d 5h 57m 19s	[REDACTED]	
24	<input type="checkbox"/>	[XTNZ]-OHA5ZIMARyMwXKMEYKTA	[+] XTNZ	OHA5ZIMARyMwXKMEYKTA	[REDACTED]	2010-03-27 01:46:33 UTC	2010-04-21 19:19:01 UTC	25d 17h 32m 28s	[REDACTED]	
25	<input type="checkbox"/>	[XTNZ]-EBFXJCMEMWpLTYAREZ2	[+] XTNZ	EBFXJCMEMWpLTYAREZ2	[REDACTED]	2009-11-11 13:00:34 UTC	2010-04-21 19:18:30 UTC	161d 6h 17m 56s	[REDACTED]	
26	<input type="checkbox"/>	[XTNZ]-XZABODIONKXLDNOVWLL	[+] XTNZ	XZABODIONKXLDNOVWLL	[REDACTED]	2010-04-21 08:58:39 UTC	2010-04-21 19:18:47 UTC	20d 10h 18m 8s	[REDACTED]	
27	<input type="checkbox"/>	[XTNZ]-LNLHUONJZGAHDOELTHUJ	[+] XTNZ	LNLHUONJZGAHDOELTHUJ	[REDACTED]	2010-03-23 04:42:40 UTC	2010-04-21 19:18:20 UTC	29d 14h 33m 40s	[REDACTED]	
28	<input type="checkbox"/>	[XTNZ]-RESDDGLVYLYFTOGFYZC	[+] XTNZ	RESDDGLVYLYFTOGFYZC	[REDACTED]	2010-04-02 09:19:50 UTC	2010-04-21 19:18:29 UTC	19d 9h 54m 39s	[REDACTED]	

File Edit View History Bookmarks Tools Help

Most Visited Getting Started Latest Headlines

BotInstances: index BotInstances: show

Threads [Bots] [Connected Bots] [Bot Types] [Machines] [IP Usages] [Countries] [Command Recurrences] [Command Types] Logged in as: 73882

Refresh Every Minute

For BotInstances Located In [REDACTED] Of Type XTNZ (Connected | [All]) Displaying BotInstances 1 - 30 of 1593 in total

< Previous 1 2 3 4 5 6 7 8 9 ... 53 54 Next >
Per Page: 25 < 100 < All

	[+]	Bot Instance	Bot Type	Machine	Last Observed IP	First Callback Time	Last Callback Time ▼	Uptime	Country	Binary Key
1	<input type="checkbox"/>	[XTNZ]-JCIeWcMYMBNIAHwKIBJ	[+] XTNZ	JCIeWcMYMBNIAHwKIBJ	[REDACTED]	2010-03-26 13:56:42 UTC	2010-04-21 19:21:03 UTC	26d 5h 24m 21s	[REDACTED]	
2	<input type="checkbox"/>	[XTNZ]-AVHTNOCSPJWODWVWYWDxB	[+] XTNZ	AVHTNOCSPJWODWVWYWDxB	[REDACTED]	2010-03-20 07:49:12 UTC	2010-04-21 19:21:00 UTC	30d 11h 31m 46s	[REDACTED]	
3	<input type="checkbox"/>	[XTNZ]-XQBjWcOKwVJEMEDGKUXL	[+] XTNZ	XQBjWcOKwVJEMEDGKUXL	[REDACTED]	2010-03-18 10:42:09 UTC	2010-04-21 19:20:54 UTC	44d 8h 38m 46s	[REDACTED]	
4	<input type="checkbox"/>	[XTNZ]-PDDWHRKVOIGwPAUZABD	[+] XTNZ	PDDWHRKVOIGwPAUZABD	[REDACTED]	2010-03-10 00:02:17 UTC	2010-04-21 19:20:54 UTC	42d 11h 18m 37s	[REDACTED]	
5	<input type="checkbox"/>	[XTNZ]-XHXWODYTIIZHMYPOJRM	[+] XTNZ	XHXWODYTIIZHMYPOJRM	[REDACTED]	2010-03-10 13:55:54 UTC	2010-04-21 19:20:54 UTC	42d 5h 25m 0s	[REDACTED]	
6	<input type="checkbox"/>	[XTNZ]-YWCCFULRCJZSWJIFGC	[+] XTNZ	YWCCFULRCJZSWJIFGC	[REDACTED]	2009-11-30 05:15:05 UTC	2010-04-21 19:20:45 UTC	142d 14h 5m 40s	[REDACTED]	
7	<input type="checkbox"/>	[XTNZ]-SESLOOPVIGGZVOKWYUN	[+] XTNZ	SESLOOPVIGGZVOKWYUN	[REDACTED]	2010-03-21 16:16:34 UTC	2010-04-21 19:20:29 UTC	31d 3h 2m 55s	[REDACTED]	
8	<input type="checkbox"/>	[XTNZ]-INYDMRYRROACSSBDTZP	[+] XTNZ	INYDMRYRROACSSBDTZP	[REDACTED]	2010-03-17 19:05:23 UTC	2010-04-21 19:20:28 UTC	35d 0h 14m 1s	[REDACTED]	
9	<input type="checkbox"/>	[XTNZ]-HUTANSRTOGKIPIZIXVEA	[+] XTNZ	HUTANSRTOGKIPIZIXVEA	[REDACTED]	2010-03-18 06:54:59 UTC	2010-04-21 19:20:28 UTC	34d 12h 25m 29s	[REDACTED]	
10	<input type="checkbox"/>	[XTNZ]-MKLDRAENRUXYHWXNDMQ	[+] XTNZ	MKLDRAENRUXYHWXNDMQ	[REDACTED]	2010-03-21 15:45:32 UTC	2010-04-21 19:20:28 UTC	31d 3h 34m 55s	[REDACTED]	
11	<input type="checkbox"/>	[XTNZ]-HOSHJVRPjWBNECEMSxK	[+] XTNZ	HOSHJVRPjWBNECEMSxK	[REDACTED]	2010-03-21 19:52:13 UTC	2010-04-21 19:20:23 UTC	30d 23h 26m 10s	[REDACTED]	
12	<input type="checkbox"/>	[XTNZ]-NCKRFLNMxJXJBIAUCH	[+] XTNZ	NCKRFLNMxJXJBIAUCH	[REDACTED]	2010-03-22 10:01:02 UTC	2010-04-21 19:20:28 UTC	30d 9h 19m 26s	[REDACTED]	
13	<input type="checkbox"/>	[XTNZ]-EKSHESSJURPILYTPBDQ	[+] XTNZ	EKSHESSJURPILYTPBDQ	[REDACTED]	2010-04-01 10:27:41 UTC	2010-04-21 19:20:21 UTC	20d 8h 52m 40s	[REDACTED]	
14	<input type="checkbox"/>	[XTNZ]-FFCKTIOMBUVFAHTRRBC	[+] XTNZ	FFCKTIOMBUVFAHTRRBC	[REDACTED]	2010-03-11 11:59:05 UTC	2010-04-21 19:20:17 UTC	41d 7h 21m 12s	[REDACTED]	
15	<input type="checkbox"/>	[XTNZ]-LNKWMUQJDRBIFERNJPEC	[+] XTNZ	LNKWMUQJDRBIFERNJPEC	[REDACTED]	2010-03-17 21:07:41 UTC	2010-04-21 19:20:17 UTC	34d 22h 12m 36s	[REDACTED]	
16	<input type="checkbox"/>	[XTNZ]-PKCKRNROSSxUTSZHTQJN	[+] XTNZ	PKCKRNROSSxUTSZHTQJN	[REDACTED]	2010-04-01 18:09:15 UTC	2010-04-21 19:20:08 UTC	20d 1h 10m 53s	[REDACTED]	
17	<input type="checkbox"/>	[XTNZ]-EVCJLNABZLXZHYG3CNyS	[+] XTNZ	EVCJLNABZLXZHYG3CNyS	[REDACTED]	2010-03-31 13:53:33 UTC	2010-04-21 19:19:47 UTC	21d 5h 25m 14s	[REDACTED]	
18	<input type="checkbox"/>	[XTNZ]-FMWNTULXYOLVPCXLAUJH	[+] XTNZ	FMWNTULXYOLVPCXLAUJH	[REDACTED]	2010-04-11 09:35:23 UTC	2010-04-21 19:19:35 UTC	41d 9h 43m 0s	[REDACTED]	
19	<input type="checkbox"/>	[XTNZ]-HWQWMYVSHWEAMEJODNA	[+] XTNZ	HWQWMYVSHWEAMEJODNA	[REDACTED]	2010-03-23 09:30:13 UTC	2010-04-21 19:19:21 UTC	29d 9h 43m 8s	[REDACTED]	
20	<input type="checkbox"/>	[XTNZ]-QYZVUYjWDOLZIIIPHOOF	[+] XTNZ	QYZVUYjWDOLZIIIPHOOF	[REDACTED]	2010-03-23 09:42:21 UTC	2010-04-21 19:19:19 UTC	29d 9h 35m 58s	[REDACTED]	
21	<input type="checkbox"/>	[XTNZ]-AGEXNMB5B0AVGxJHLOPA	[+] XTNZ	AGEXNMB5B0AVGxJHLOPA	[REDACTED]	2010-03-22 06:23:50 UTC	2010-04-21 19:19:07 UTC	30d 12h 55m 17s	[REDACTED]	
22	<input type="checkbox"/>	[XTNZ]-MRSGJRZxUSyNMUPxwVIO	[+] XTNZ	MRSGJRZxUSyNMUPxwVIO	[REDACTED]	2010-04-11 09:29:10 UTC	2010-04-21 19:19:07 UTC	29d 9h 49m 57s	[REDACTED]	
23	<input type="checkbox"/>	[XTNZ]-CXDTLZNAZJINTVXAQDQW	[+] XTNZ	CXDTLZNAZJINTVXAQDQW	[REDACTED]	2010-03-26 13:21:48 UTC	2010-04-21 19:19:07 UTC	26d 5h 57m 19s	[REDACTED]	
24	<input type="checkbox"/>	[XTNZ]-OHASZJMBRYMwXKMEYKTA	[+] XTNZ	OHASZJMBRYMwXKMEYKTA	[REDACTED]	2010-03-27 01:45:53 UTC	2010-04-21 19:19:01 UTC	25d 17h 35m 26s	[REDACTED]	
25	<input type="checkbox"/>	[XTNZ]-FBFXJCMEMwALTYAREZ2	[+] XTNZ	FBFXJCMEMwALTYAREZ2	[REDACTED]	2009-11-11 13:00:34 UTC	2010-04-21 19:18:30 UTC	161d 6h 17m 56s	[REDACTED]	
26	<input type="checkbox"/>	[XTNZ]-XZABODIONKXLDNOVWLL	[+] XTNZ	XZABODIONKXLDNOVWLL	[REDACTED]	2010-04-01 08:58:39 UTC	2010-04-21 19:16:47 UTC	20d 10h 18m 8s	[REDACTED]	
27	<input type="checkbox"/>	[XTNZ]-LNLHUONJZGAHDOELTHJU	[+] XTNZ	LNLHUONJZGAHDOELTHJU	[REDACTED]	2010-03-23 04:42:40 UTC	2010-04-21 19:16:20 UTC	29d 14h 33m 40s	[REDACTED]	
28	<input type="checkbox"/>	[XTNZ]-RESIDGLVYLYFTOGFYZC	[+] XTNZ	RESIDGLVYLYFTOGFYZC	[REDACTED]	2010-04-02 09:13:53 UTC	2010-04-21 19:14:29 UTC	19d 9h 54m 33s	[REDACTED]	

File Edit View History Bookmarks Tools Help

Most Visited Getting Started Latest Headlines

BotInstances: index BotInstances: show

Threads [Bots] [Connected Bots] [Bot Types] [Machines] [IP Usages] [Countries] [Command Recurrences] [Command Types] Logged In as: 79882

Refresh Every Minute

For BotInstances Located In [REDACTED] Of Type XTNZ (Connected | [All]) Displaying BotInstances 1 - 30 of 1593 in total

« Previous 1 2 3 4 5 6 7 8 9 ... 53 54 Next »
Per Page: 25 < 50 < 100 < All

	[+]	Bot Instance	Bot Type	Machine	Last Callback Time	First Callback Time	Last Callback Time	Lifetime	Binary Key
1	<input type="checkbox"/>	[XTNZ]-tmpPNZNITDMTNWZICNDF	[+] XTNZ	tmpPNZNITDMTNWZICNDF	[REDACTED]	2010-04-21 10:47:31 UTC	2010-04-21 13:34:32 UTC	2h 47m 1s	[REDACTED]
2	<input type="checkbox"/>	[XTNZ]-tmpSZOLLXJUZWGKTHDLG	[+] XTNZ	tmpSZOLLXJUZWGKTHDLG	[REDACTED]	2010-04-21 07:01:26 UTC	2010-04-21 08:20:08 UTC	1h 18m 42s	[REDACTED]
3	<input type="checkbox"/>	[XTNZ]-tmpYJFMQUHYRHSYGROR	[+] XTNZ	tmpYJFMQUHYRHSYGROR	[REDACTED]	2010-04-21 03:53:50 UTC	2010-04-21 10:44:19 UTC	6h 50m 29s	[REDACTED]
4	<input type="checkbox"/>	[XTNZ]-tmpEKTAZMEEOKMQYJLGC	[+] XTNZ	tmpEKTAZMEEOKMQYJLGC	[REDACTED]	2010-04-20 13:42:50 UTC	2010-04-20 19:52:47 UTC	1h 3m 57s	[REDACTED]
5	<input type="checkbox"/>	[XTNZ]-tmpJHTBAYONDKOKIGTH	[+] XTNZ	tmpJHTBAYONDKOKIGTH	[REDACTED]	2010-04-17 02:53:47 UTC	2010-04-17 02:38:47 UTC		[REDACTED]
6	<input type="checkbox"/>	[XTNZ]-tmpRRISOSKVMRRGCGIR	[+] XTNZ	tmpRRISOSKVMRRGCGIR	[REDACTED]	2010-04-15 12:14:15 UTC	2010-04-15 13:37:18 UTC	23m 3s	[REDACTED]
7	<input type="checkbox"/>	[XTNZ]-tmpGGZTYEVGCCZLYLBJM	[+] XTNZ	tmpGGZTYEVGCCZLYLBJM	[REDACTED]	2010-04-15 11:55:50 UTC	2010-04-15 12:03:19 UTC	26m 29s	[REDACTED]
8	<input type="checkbox"/>	[XTNZ]-tmpEDCCIKWCGRPDIOEZA	[+] XTNZ	tmpEDCCIKWCGRPDIOEZA	[REDACTED]	2010-04-15 05:22:57 UTC	2010-04-15 10:49:35 UTC	5h 26m 42s	[REDACTED]
9	<input type="checkbox"/>	[XTNZ]-tmpKOTDKOGWQBGDXMWGC	[+] XTNZ	tmpKOTDKOGWQBGDXMWGC	[REDACTED]	2010-04-15 03:47:11 UTC	2010-04-15 04:49:31 UTC	1h 2m 20s	[REDACTED]
10	<input type="checkbox"/>	[XTNZ]-tmpWCFGGCQIKBAZZAGUH	[+] XTNZ	tmpWCFGGCQIKBAZZAGUH	[REDACTED]	2010-04-14 10:42:36 UTC	2010-04-14 14:05:43 UTC	3h 23m 7s	[REDACTED]
11	<input type="checkbox"/>	[XTNZ]-tmpXGEEADRYZTLUJKEI	[+] XTNZ	tmpXGEEADRYZTLUJKEI	[REDACTED]	2010-04-14 04:39:07 UTC	2010-04-14 09:51:57 UTC	5h 12m 50s	[REDACTED]
12	<input type="checkbox"/>	[XTNZ]-tmpXDPKPFPAIOJNNYNID	[+] XTNZ	tmpXDPKPFPAIOJNNYNID	[REDACTED]	2010-04-14 03:44:43 UTC	2010-04-14 03:59:45 UTC	2h 13m 5s	[REDACTED]
13	<input type="checkbox"/>	[XTNZ]-tmpQVNIERZFOYNYGWB	[+] XTNZ	tmpQVNIERZFOYNYGWB	[REDACTED]	2010-04-13 11:38:57 UTC	2010-04-13 15:26:09 UTC	3h 47m 12s	[REDACTED]
14	<input type="checkbox"/>	[XTNZ]-tmpAOTYUWIAAOSXPICXT	[+] XTNZ	tmpAOTYUWIAAOSXPICXT	[REDACTED]	2010-04-13 09:15:10 UTC	2010-04-13 09:47:19 UTC	32m 9s	[REDACTED]
15	<input type="checkbox"/>	[XTNZ]-tmpIQUDBWCPJARXJDKCD	[+] XTNZ	tmpIQUDBWCPJARXJDKCD	[REDACTED]	2010-04-13 05:41:22 UTC	2010-04-13 11:35:43 UTC	5h 55m 21s	[REDACTED]
16	<input type="checkbox"/>	[XTNZ]-tmpAVQECSDHE2GOQJANEI	[+] XTNZ	tmpAVQECSDHE2GOQJANEI	[REDACTED]	2010-04-13 05:26:47 UTC	2010-04-13 05:36:47 UTC	10m 0s	[REDACTED]
17	<input type="checkbox"/>	[XTNZ]-tmpLDKUFENKOKIKMINID	[+] XTNZ	tmpLDKUFENKOKIKMINID	[REDACTED]	2010-04-12 09:25:25 UTC	2010-04-12 09:28:15 UTC	6m 48s	[REDACTED]
18	<input type="checkbox"/>	[XTNZ]-tmpQNWIOPUAIIHYMJWFSJ	[+] XTNZ	tmpQNWIOPUAIIHYMJWFSJ	[REDACTED]	2010-04-12 03:17:52 UTC	2010-04-12 12:31:45 UTC	3h 23m 48s	[REDACTED]
19	<input type="checkbox"/>	[XTNZ]-tmpTQKQCCJEDMSUMVOS	[+] XTNZ	tmpTQKQCCJEDMSUMVOS	[REDACTED]	2010-04-12 03:15:57 UTC	2010-04-12 03:59:55 UTC	43m 2s	[REDACTED]
20	<input type="checkbox"/>	[XTNZ]-tmpUBCVDAVZMGBMGWLRX	[+] XTNZ	tmpUBCVDAVZMGBMGWLRX	[REDACTED]	2010-04-11 11:00:17 UTC	2010-04-12 08:10:39 UTC	21h 18m 46s	[REDACTED]
21	<input type="checkbox"/>	[XTNZ]-tmpWZNSFOHURDJGNMFL	[+] XTNZ	tmpWZNSFOHURDJGNMFL	[REDACTED]	2010-04-11 07:33:33 UTC	2010-04-11 10:54:57 UTC	3h 16m 24s	[REDACTED]
22	<input type="checkbox"/>	[XTNZ]-tmpEZQSEZJXOHJIKOKRVI	[+] XTNZ	tmpEZQSEZJXOHJIKOKRVI	[REDACTED]	2010-04-11 05:49:55 UTC	2010-04-11 07:35:23 UTC	1h 45m 25s	[REDACTED]
23	<input type="checkbox"/>	[XTNZ]-tmpWZVAPKQCCJFJEDCMJ	[+] XTNZ	tmpWZVAPKQCCJFJEDCMJ	[REDACTED]	2010-04-11 05:17:14 UTC	2010-04-11 05:20:28 UTC	3m 1-s	[REDACTED]
24	<input type="checkbox"/>	[XTNZ]-tmpYRFQVAOORCXYVIBX	[+] XTNZ	tmpYRFQVAOORCXYVIBX	[REDACTED]	2010-04-11 04:44:17 UTC	2010-04-11 05:46:11 UTC	1h 1m 44s	[REDACTED]
25	<input type="checkbox"/>	[XTNZ]-tmpMGNZCLTWLUSNZDVGJN	[+] XTNZ	tmpMGNZCLTWLUSNZDVGJN	[REDACTED]	2010-04-11 04:03:14 UTC	2010-04-11 14:04:36 UTC	10h 1m 22s	[REDACTED]
26	<input type="checkbox"/>	[XTNZ]-tmpVJFZPWYBJLMEVQJ	[+] XTNZ	tmpVJFZPWYBJLMEVQJ	[REDACTED]	2010-04-10 11:17:38 UTC	2010-04-11 04:10:50 UTC	17h 23m 22s	[REDACTED]
27	<input type="checkbox"/>	[XTNZ]-tmpOLEQUPRCRTNHAGWM	[+] XTNZ	tmpOLEQUPRCRTNHAGWM	[REDACTED]	2010-04-10 07:47:18 UTC	2010-04-10 11:39:23 UTC	3h 22m 3s	[REDACTED]
28	<input type="checkbox"/>	[XTNZ]-tmpHOEKTGEWDCGCLKJI	[+] XTNZ	tmpHOEKTGEWDCGCLKJI	[REDACTED]	2010-04-10 06:25:54 UTC	2010-04-10 07:11:37 UTC	45m 43s	[REDACTED]

File Edit View History Bookmarks Tools Help

Most Visited Getting Started Latest Headlines

BotInstances: index BotInstances: show

[Herd] [Bots] [Connected Bots] [Bot Types] [Machines] [IP Usages] [Countries] [Command Recurrences] [Command Types] Logged in as: 73882

Listing Herds

[New herd](#)

Herd	Action
[REDACTED] nethack	Show All / Show Connected / Edit / Hide
[REDACTED] xtnz	Show All / Show Connected / Edit / Hide
Some Awesome Herd	Show All / Show Connected / Edit / Hide

[New herd](#)

File Edit View History Bookmarks Tools Help

Most Visited Getting Started Latest Headlines

BotInstances: index BotInstances: show

[Herd] [Bots] [Connected Bots] [Bot Types] [Machines] [IP Usages] [Countries] [Command Recurrences] [Command Types] Logged in as: 73882

Listing Herds

[New herd](#)

Herd	Action
[REDACTED] nethack	Show All / Show Connected / Edit / Hide
[REDACTED] xtnz	Show All / Show Connected / Edit / Hide
Some Awesome Herd	Show All / Show Connected / Edit / Hide

[New herd](#)

File Edit View History Bookmarks Tools Help

Most Visited Getting Started Latest Headlines

BotInstances: new BotInstances: show

[Herd] [Bots] [Connected Bots] [Bot Types] [Machines] [IP Usages] [Countries] [Command Recurrences] [Command Types] **Logged in as: 73882**

New herd

Name

File Edit View History Bookmarks Tools Help

Most Visited Getting Started Latest Headlines

BotInstances: edit BotInstances: show

[Herd] [Bots] [Connected Bots] [Bot Types] [Machines] [IP Usages] [Countries] [Command Recurrences] [Command Types]

Logged in as: 73882

Editing Herd 'My New Herd' < [M] [X] >

Update and ... [Stay Here] [View Herd] [View Connected Herd] [View Index]	Bot Types (Any) Choose A Bot Type	Currently In Country (Any) Choose A Country	Currently In Netblock (Any) Add Netblock
		Ever In Country (Any) Choose A Country	Historically In Netblock (Any) Add Netblock
			Bot Instances (Any) Add Bot Instance

File Edit View History Bookmarks Tools Help

Most Visited Getting Started Latest Headlines

BotInstances: edit BotInstances: show

[Herds] [Bots] [Connected Bots] [Bot Types] [Machines] [IP Usages] [Countries] [Command Recurrences] [Command Types]

Logged in as: 73882

Editing Herd 'My New Herd' < [M] [I] >

Update and ... [Stay Here] [View Herd] [View Connected Herd] [View Index]	Bot Types (Any) Choose A Bot Type Choose A Bot Type HEPB NZYT TURD XTNC	Currently In Country (Any) Choose A Country	Currently In Netblock (Any) Add Netblock
		Ever In Country (Any) Choose A Country	Historically In Netblock (Any) Add Netblock
			Bot Instances (Any) Add Bot Instance

File Edit View History Bookmarks Tools Help

Most Visited Getting Started Latest Headlines

BotInstances: edit BotInstances: show

[Herds] [Bots] [Connected Bots] [Bot Types] [Machines] [IP Usages] [Countries] [Command Recurrences] [Command Types]

Logged in as: 73862

Editing Herd 'My New Herd' ◀ ▶

Update and ... Stay Here View Herd View Connected Herd View Index	Bot Types (<input checked="" type="radio"/> Any Of <input type="radio"/> None Of)	Currently In Country (Any)	Currently In Netblock (Any)
	Choose A Bot Type	Choose A Country	Add Netblock
	<input checked="" type="checkbox"/> XTNZ	Ever In Country (Any)	Historically In Netblock (Any)
		Choose A Country	Add Netblock
		Bot Instances (Any)	Add Bot Instance

File Edit View History Bookmarks Tools Help

Most Visited Getting Started Latest Headlines

BotInstances: edit BotInstances: show

[Herds] [Bots] [Connected Bots] [Bot Types] [Machines] [IP Usages] [Countries] [Command Recurrences] [Command Types] Logged in as: 73882

Editing Herd 'My New Herd' ◀ ▶

Update and ... Stay Here View Herd View Connected Herd View Index	Bot Types (<input checked="" type="radio"/> Any Of <input type="radio"/> None Of)	Currently In Country (Any)	Currently In Netblock (Any)
	Choose A Bot Type	Choose A Country	Add Netblock
	<input checked="" type="checkbox"/> XTNZ	Ever In Country (Any)	Historically In Netblock (Any)
		Choose A Country	Add Netblock
		Bot Instances (Any)	Add Bot Instance

File Edit View History Bookmarks Tools Help

Most Visited Getting Started Latest Headlines

BotInstances: index BotInstances: show

Logged In as: 73882

Refresh Every Minute

For Herd 'My New Herd' (Connected | [All]) Displaying BotInstances 1 - 30 of 3556 in total

« Previous 1 2 3 4 5 6 7 8 9 ... 118 119 Next »
Per Page: 25 < 50 < 100 < All

	[+]	Bot Instance	Bot Type	Machine	Last Observed IP	First Callback Time	Last Callback Time ▼	Lifetime	Country	Binary Key
1	<input type="checkbox"/>	[XTNZ]-BOGPMHKNXLHVAVUXFOVOM	[+] XTNZ	BOGPMHKNXLHVAVUXFOVOM		2010-03-10 15:53:36 UTC	2010-04-21 19:48:52 UTC	42d 2h 55m 16s		
2	<input type="checkbox"/>	[XTNZ]-JCBURBWGXTSHOXKXSHNG	[+] XTNZ	JCBURBWGXTSHOXKXSHNG		2010-03-17 10:49:34 UTC	2010-04-21 19:48:52 UTC	35d 0h 59m 18s		
8	<input type="checkbox"/>	[XTNZ]-OHTFJEDWUXFBNDMODONI	[+] XTNZ	OHTFJEDWUXFBNDMODONI		2010-03-23 09:44:11 UTC	2010-04-21 19:48:52 UTC	29d 15h 4m 42s		
4	<input type="checkbox"/>	[XTNZ]-FTVIO12PMWMMHRTVEVPG	[+] XTNZ	FTVIO12PMWMMHRTVEVPG		2010-04-01 20:34:06 UTC	2010-04-21 19:48:52 UTC	19d 23h 14m 46s		
5	<input type="checkbox"/>	[XTNZ]-AFW10M00FQVKTZNKJDOC	[+] XTNZ	AFW10M00FQVKTZNKJDOC		2010-04-01 20:34:19 UTC	2010-04-21 19:48:52 UTC	19d 23h 14m 33s		
6	<input type="checkbox"/>	[XTNZ]-SRUKDPYTGQIVWCHAWVTL	[+] XTNZ	SRUKDPYTGQIVWCHAWVTL		2010-04-01 20:52:52 UTC	2010-04-21 19:48:52 UTC	19d 23h 55m 0s		
7	<input type="checkbox"/>	[XTNZ]-QKXJLBTTOOZNLKDPVVMZ	[+] XTNZ	QKXJLBTTOOZNLKDPVVMZ		2010-04-09 14:11:58 UTC	2010-04-21 19:48:38 UTC	12d 5h 36m 46s		
8	<input type="checkbox"/>	[XTNZ]-FMWNTULXVOLVPCXLAUJH	[+] XTNZ	FMWNTULXVOLVPCXLAUJH		2010-03-11 09:36:28 UTC	2010-04-21 19:48:37 UTC	41d 10h 12m 9s		
9	<input type="checkbox"/>	[XTNZ]-IERRPDREDPIYKOWDUIHH	[+] XTNZ	IERRPDREDPIYKOWDUIHH		2010-03-27 13:14:89 UTC	2010-04-21 19:48:28 UTC	25d 6h 34m 39s		
10	<input type="checkbox"/>	[XTNZ]-WHOBIGFYHJSM8GCFMZSH	[+] XTNZ	WHOBIGFYHJSM8GCFMZSH		2010-03-22 21:36:37 UTC	2010-04-21 19:48:17 UTC	29d 22h 11m 40s		
11	<input type="checkbox"/>	[XTNZ]-LQKUNHPCHTSWOZULQPPB	[+] XTNZ	LQKUNHPCHTSWOZULQPPB		2010-03-22 10:39:07 UTC	2010-04-21 19:48:10 UTC	30d 9h 7m 3s		
12	<input type="checkbox"/>	[XTNZ]-QHASZIMRBYMWXKMEVKT&	[+] XTNZ	QHASZIMRBYMWXKMEVKT&		2010-03-27 01:46:33 UTC	2010-04-21 19:48:11 UTC	25d 18h 1m 37s		
13	<input type="checkbox"/>	[XTNZ]-NGVWGSPPCADQDQMSVIVQW	[+] XTNZ	NGVWGSPPCADQDQMSVIVQW		2010-03-29 10:25:28 UTC	2010-04-21 19:48:10 UTC	23d 9h 22m 42s		
14	<input type="checkbox"/>	[XTNZ]-VWGFCEFULROUZSWJHFOC	[+] XTNZ	VWGFCEFULROUZSWJHFOC		2009-11-30 05:15:05 UTC	2010-04-21 19:48:01 UTC	142d 14h 32m 56s		
15	<input type="checkbox"/>	[XTNZ]-IUCWQTDONDFGUARDOSVOK	[+] XTNZ	IUCWQTDONDFGUARDOSVOK		2010-03-22 03:17:53 UTC	2010-04-21 19:47:59 UTC	30d 16h 30m 6s		
16	<input type="checkbox"/>	[XTNZ]-AGEXNMB8BOAVGXJHLOBA	[+] XTNZ	AGEXNMB8BOAVGXJHLOBA		2010-03-22 06:23:50 UTC	2010-04-21 19:47:59 UTC	30d 13h 24m 9s		
17	<input type="checkbox"/>	[XTNZ]-M8GCRZKXISMNMUPXWNIO	[+] XTNZ	M8GCRZKXISMNMUPXWNIO		2010-03-23 09:24:11 UTC	2010-04-21 19:47:59 UTC	29d 10h 15m 49s		
18	<input type="checkbox"/>	[XTNZ]-CXETLZNAZJTVX&QJGW	[+] XTNZ	CXETLZNAZJTVX&QJGW		2010-03-26 13:21:48 UTC	2010-04-21 19:47:59 UTC	26d 6h 26m 11s		
19	<input type="checkbox"/>	[XTNZ]-XPINCPGRLLCKCRPNCOTN	[+] XTNZ	XPINCPGRLLCKCRPNCOTN		2010-03-30 21:07:09 UTC	2010-04-21 19:47:47 UTC	21d 22h 40m 32s		
20	<input type="checkbox"/>	[XTNZ]-XHWODYTIIHVMYPOJRM	[+] XTNZ	XHWODYTIIHVMYPOJRM		2010-03-10 13:55:54 UTC	2010-04-21 19:47:39 UTC	42d 5h 51m 45s		
21	<input type="checkbox"/>	[XTNZ]-INYDMRYRROACS88BDTZP	[+] XTNZ	INYDMRYRROACS88BDTZP		2010-03-17 19:06:28 UTC	2010-04-21 19:47:39 UTC	35d 0h 41m 11s		
22	<input type="checkbox"/>	[XTNZ]-SESIQBPVICZVOKIWIYJIN	[+] XTNZ	SESIQBPVICZVOKIWIYJIN		2010-03-21 16:16:34 UTC	2010-04-21 19:47:39 UTC	31d 3h 31m 5s		
23	<input type="checkbox"/>	[XTNZ]-QGRUCUWGTUBUNCQVEXWPL	[+] XTNZ	QGRUCUWGTUBUNCQVEXWPL		2010-03-22 08:37:13 UTC	2010-04-21 19:47:39 UTC	30d 11h 10m 26s		
24	<input type="checkbox"/>	[XTNZ]-DFEFDNZVJKQHZ&OJXFHU	[+] XTNZ	DFEFDNZVJKQHZ&OJXFHU		2010-03-31 13:04:41 UTC	2010-04-21 19:47:39 UTC	21d 6h 42m 58s		
25	<input type="checkbox"/>	[XTNZ]-EKSHES8IURDIIYTP&DO	[+] XTNZ	EKSHES8IURDIIYTP&DO		2010-04-01 10:27:41 UTC	2010-04-21 19:47:39 UTC	20d 9h 10m 58s		
26	<input type="checkbox"/>	[XTNZ]-CTYEMNPOQOQDLSYZSUTJ	[+] XTNZ	CTYEMNPOQOQDLSYZSUTJ		2009-12-01 15:04:12 UTC	2010-04-21 19:47:30 UTC	141d 4h 43m 18s		
27	<input type="checkbox"/>	[XTNZ]-HULAN8CBQGLKZLXVFA	[+] XTNZ	HULAN8CBQGLKZLXVFA		2010-03-18 06:54:59 UTC	2010-04-21 19:47:30 UTC	34d 12h 52m 31s		
28	<input type="checkbox"/>	[XTNZ]-PQUUCQTDQEDTYRUMJ&BAL	[+] XTNZ	PQUUCQTDQEDTYRUMJ&BAL		2010-03-21 21:16:16 UTC	2010-04-21 19:47:30 UTC	30d 23h 21m 14s		

File Edit View History Bookmarks Tools Help

Most Visited Getting Started Latest Headlines

BotInstances: index BotInstances: show

Herds: [Bots] [Connected Bots] [Bot Types] [Machines] [IP Usages] [Countries] [Command Recurrences] [Command Types] Logged in as: 73882

Refresh Every Minute

For Herd 'My New Herd' ([Connected](#) | [\[All\]](#))

Displaying BotInstances 1 - 30 of 3556 in total

« Previous 1 2 3 4 5 6 7 8 9 ... 118 119 Next »
Per Page: 25 < 50 < 100 < All

	[+]	Bot Instance	Bot Type	Machine	Last Observed IP	First Callback Time	Last Callback Time ▼	Lifetime	Country	Binary Key
1	<input type="checkbox"/>	[XTNZ]-BOGPMHKNLHVVAUXFOVOM	[+] XTNZ	BOGPMHKNLHVVAUXFOVOM		2010-03-10 16:53:36 UTC	2010-04-21 19:48:52 UTC	42d 2h 55m 16s		
2	<input type="checkbox"/>	[XTNZ]-JCBJBBWCXTSHOXXYGHNG	[+] XTNZ	JCBJBBWCXTSHOXXYGHNG		2010-03-17 18:49:34 UTC	2010-04-21 19:48:52 UTC	35d 0h 55m 18s		
8	<input type="checkbox"/>	[XTNZ]-OHTFJEDWUXFBNDMODONI	[+] XTNZ	OHTFJEDWUXFBNDMODONI		2010-03-23 04:44:11 UTC	2010-04-21 19:48:52 UTC	29d 15h 4m 42s		
4	<input type="checkbox"/>	[XTNZ]-FTV1012MWWMMHGTVEVPR	[+] XTNZ	FTV1012MWWMMHGTVEVPR		2010-04-01 20:04:06 UTC	2010-04-21 19:48:52 UTC	19d 23h 14m 46s		
5	<input type="checkbox"/>	[XTNZ]-AFW10M00FQVKTZNKJDUC	[+] XTNZ	AFW10M00FQVKTZNKJDUC		2010-04-01 20:34:19 UTC	2010-04-21 19:48:52 UTC	19d 23h 14m 33s		
6	<input type="checkbox"/>	[XTNZ]-SRUKDPYTGCTVWOHAWVTL	[+] XTNZ	SRUKDPYTGCTVWOHAWVTL		2010-04-01 20:52:52 UTC	2010-04-21 19:48:52 UTC	19d 22h 56m 0s		
7	<input type="checkbox"/>	[XTNZ]-QKXJLBTTOOZNLKDPVVMZ	[+] XTNZ	QKXJLBTTOOZNLKDPVVMZ		2010-04-01 14:11:52 UTC	2010-04-21 19:48:33 UTC	12d 5h 36m 45s		
8	<input type="checkbox"/>	[XTNZ]-FMWNTULXVOLVPCXLAUJH	[+] XTNZ	FMWNTULXVOLVPCXLAUJH		2010-03-11 09:36:26 UTC	2010-04-21 19:48:37 UTC	41d 10h 12m 9s		
9	<input type="checkbox"/>	[XTNZ]-IERRPDRDPYKOWDUIHH	[+] XTNZ	IERRPDRDPYKOWDUIHH		2010-03-27 13:24:39 UTC	2010-04-21 19:48:28 UTC	25d 6h 34m 19s		
10	<input type="checkbox"/>	[XTNZ]-WHOB1GFYH1SMBGCFMZSH	[+] XTNZ	WHOB1GFYH1SMBGCFMZSH		2010-03-22 21:36:37 UTC	2010-04-21 19:48:17 UTC	29d 22h 11m 40s		
11	<input type="checkbox"/>	[XTNZ]-LQKUNHPCHTSWOZULOPPB	[+] XTNZ	LQKUNHPCHTSWOZULOPPB		2010-03-22 10:39:37 UTC	2010-04-21 19:48:10 UTC	30d 5h 5m 3s		
12	<input type="checkbox"/>	[XTNZ]-OHSZJMBRYMXXKMFYKTA	[+] XTNZ	OHSZJMBRYMXXKMFYKTA		2010-03-27 01:46:32 UTC	2010-04-21 19:48:10 UTC	25d 18h 1m 37s		
13	<input type="checkbox"/>	[XTNZ]-NGYWGSPPCADQOMSVIVQW	[+] XTNZ	NGYWGSPPCADQOMSVIVQW		2010-03-29 10:25:20 UTC	2010-04-21 19:48:10 UTC	23d 5h 22m 42s		
14	<input type="checkbox"/>	[XTNZ]-VWGCFFULROUZSWJHFOC	[+] XTNZ	VWGCFFULROUZSWJHFOC		2009-11-31 05:57:05 UTC	2010-04-21 19:48:07 UTC	142d 14h 32m 56s		
15	<input type="checkbox"/>	[XTNZ]-IUCWQTDON0EGUARDOSVOK	[+] XTNZ	IUCWQTDON0EGUARDOSVOK		2010-03-22 09:27:53 UTC	2010-04-21 19:47:59 UTC	50d 16h 20m 6s		
16	<input type="checkbox"/>	[XTNZ]-AGEXNMBSSBOAVGXJHLOPA	[+] XTNZ	AGEXNMBSSBOAVGXJHLOPA		2010-03-22 06:23:50 UTC	2010-04-21 19:47:59 UTC	30d 13h 24m 9s		
17	<input type="checkbox"/>	[XTNZ]-KRSGRZKUSMNMUXWNLQ	[+] XTNZ	KRSGRZKUSMNMUXWNLQ		2010-03-23 09:29:11 UTC	2010-04-21 19:47:59 UTC	29d 10h 18m 49s		
18	<input type="checkbox"/>	[XTNZ]-CXETLZNAZJN1TVXZQJGW	[+] XTNZ	CXETLZNAZJN1TVXZQJGW		2010-03-25 13:21:40 UTC	2010-04-21 19:47:59 UTC	26d 6h 26m 11s		
19	<input type="checkbox"/>	[XTNZ]-XPINCPGR1C1KQ3PNCOTN	[+] XTNZ	XPINCPGR1C1KQ3PNCOTN		2010-03-31 21:37:39 UTC	2010-04-21 19:47:41 UTC	21d 22h 40m 32s		
20	<input type="checkbox"/>	[XTNZ]-XHWQDY11ZHYMYPOJRM	[+] XTNZ	XHWQDY11ZHYMYPOJRM		2010-03-10 19:55:54 UTC	2010-04-21 19:47:39 UTC	42d 5h 51m 45s		
21	<input type="checkbox"/>	[XTNZ]-INYDMRYRROACSSBBDTZP	[+] XTNZ	INYDMRYRROACSSBBDTZP		2010-03-17 19:30:23 UTC	2010-04-21 19:47:39 UTC	35d 0h 41m 11s		
22	<input type="checkbox"/>	[XTNZ]-SESLCOPV1CGZVOKWY1M	[+] XTNZ	SESLCOPV1CGZVOKWY1M		2010-03-21 16:26:34 UTC	2010-04-21 19:47:39 UTC	31d 3h 31m 5s		
23	<input type="checkbox"/>	[XTNZ]-QGRUCWGTUBUNCQVEXUPL	[+] XTNZ	QGRUCWGTUBUNCQVEXUPL		2010-03-24 08:07:10 UTC	2010-04-21 19:47:39 UTC	30d 11h 10m 26s		
24	<input type="checkbox"/>	[XTNZ]-DFEFDNZV1KQHZAOIXFHU	[+] XTNZ	DFEFDNZV1KQHZAOIXFHU		2010-03-31 13:14:41 UTC	2010-04-21 19:47:39 UTC	21d 6h 42m 58s		
25	<input type="checkbox"/>	[XTNZ]-EKSHSS1URP11VTPADO	[+] XTNZ	EKSHSS1URP11VTPADO		2010-04-01 10:27:41 UTC	2010-04-21 19:47:39 UTC	20d 0h 10m 58s		
26	<input type="checkbox"/>	[XTNZ]-CTYEMNPOOQOOLSYSUTJ	[+] XTNZ	CTYEMNPOOQOOLSYSUTJ		2009-12-01 15:34:12 UTC	2010-04-21 19:47:30 UTC	141d 4h 43m 18s		
27	<input type="checkbox"/>	[XTNZ]-HUTANSCBIOGK1CZLXVEA	[+] XTNZ	HUTANSCBIOGK1CZLXVEA		2010-03-18 06:54:55 UTC	2010-04-21 19:47:30 UTC	34d 12h 52m 35s		
28	<input type="checkbox"/>	[XTNZ]-PQUUCQTD1EDTYR1UMJRAL	[+] XTNZ	PQUUCQTD1EDTYR1UMJRAL		2010-03-21 21:16:16 UTC	2010-04-21 19:47:30 UTC	30d 22h 31m 14s		

File Edit View History Bookmarks Tools Help

Most Visited Getting Started Latest Headlines

BotInstances: index BotInstances: show

Herds: [Bots] [Connected Bots] [Bot Types] [Machines] [IP Usages] [Countries] [Command Recurrences] [Command Types] Logged in as: 73882

Refresh Every Minute

For Herd 'My New Herd' ([Connected] | All) Displaying BotInstances 1 - 30 of 40 in total

< Previous 1 2 Next >
Per Page: 25 < 50 < 100 < All

	[+]	Bot Instance	Bot Type	Machine	Last Observed IP	First Callback Time	Last Callback Time ▼	Uptime	Country	Binary Key
1	<input type="checkbox"/>	[XTNZ]-OHTFJEDWUXFBNDDMODNT	[+] XTNZ	OHTFJEDWUXFBNDDMODNT		2010-03-23 04:44:10 UTC	2010-04-21 19:50:29 UTC	20d 15h 6m 19s		
2	<input type="checkbox"/>	[XTNZ]-JEBBDDBEDPIYKOWDJUHH	[+] XTNZ	JEBBDDBEDPIYKOWDJUHH		2010-03-27 13:14:09 UTC	2010-04-21 19:50:29 UTC	25d 6h 36m 20s		
3	<input type="checkbox"/>	[XTNZ]-ODKISFYLYKXHKRZV_POC	[+] XTNZ	ODKISFYLYKXHKRZV_POC		2010-04-01 19:07:19 UTC	2010-04-21 19:50:29 UTC	20d 0h 43m 10s		
4	<input type="checkbox"/>	[XTNZ]-FTYIQJZMAMMHHIGTYEVRG	[+] XTNZ	FTYIQJZMAMMHHIGTYEVRG		2010-04-01 20:34:06 UTC	2010-04-21 19:50:29 UTC	19d 23h 16m 23s		
5	<input type="checkbox"/>	[XTNZ]-AFWIDMODQFKVTZNMJQUC	[+] XTNZ	AFWIDMODQFKVTZNMJQUC		2010-04-01 20:34:19 UTC	2010-04-21 19:50:29 UTC	19d 23h 16m 10s		
6	<input type="checkbox"/>	[XTNZ]-SRUKDFYTOGIVWCHAWYTL	[+] XTNZ	SRUKDFYTOGIVWCHAWYTL		2010-04-01 20:52:52 UTC	2010-04-21 19:50:29 UTC	19d 22h 57m 37s		
7	<input type="checkbox"/>	[XTNZ]-WBOBGEFYHJSMRGGCFVZSH	[+] XTNZ	WBOBGEFYHJSMRGGCFVZSH		2010-03-22 21:06:37 UTC	2010-04-21 19:50:24 UTC	27d 22h 13m 47s		
8	<input type="checkbox"/>	[XTNZ]-NGVWGSPPCADDCMSVIVLWV	[+] XTNZ	NGVWGSPPCADDCMSVIVLWV		2010-03-29 11:25:28 UTC	2010-04-21 19:50:16 UTC	23d 9h 24m 50s		
9	<input type="checkbox"/>	[XTNZ]-LOKUNHPCHTSWOZULOPPR	[+] XTNZ	LOKUNHPCHTSWOZULOPPR		2010-03-22 10:39:07 UTC	2010-04-21 19:50:16 UTC	30d 9h 11m 9s		
10	<input type="checkbox"/>	[XTNZ]-Q-ASZJMBRYMXXKMFYKTA	[+] XTNZ	Q-ASZJMBRYMXXKMFYKTA		2010-03-27 01:46:33 UTC	2010-04-21 19:50:14 UTC	25d 18h 3m 41s		
11	<input type="checkbox"/>	[XTNZ]-YVWGCFFULRCJZSWJIEGCG	[+] XTNZ	YVWGCFFULRCJZSWJIEGCG		2009-11-30 05:15:05 UTC	2010-04-21 19:50:09 UTC	142d 14h 35m 1s		
12	<input type="checkbox"/>	[XTNZ]-JCBJRWXKISHQXXSHRG	[+] XTNZ	JCBJRWXKISHQXXSHRG		2010-03-17 18:49:34 UTC	2010-04-21 19:50:06 UTC	35d 1h 0m 32s		
13	<input type="checkbox"/>	[XTNZ]-LUCWOTDQNOFGUARDQVQX	[+] XTNZ	LUCWOTDQNOFGUARDQVQX		2010-03-22 03:17:53 UTC	2010-04-21 19:50:04 UTC	30d 16h 32m 11s		
14	<input type="checkbox"/>	[XTNZ]-AGEXNMBSDQAVGXJHLOPA	[+] XTNZ	AGEXNMBSDQAVGXJHLOPA		2010-03-27 05:23:50 UTC	2010-04-21 19:50:04 UTC	27d 13h 26m 14s		
15	<input type="checkbox"/>	[XTNZ]-MRSQJRZXUSMNMUPXWNIO	[+] XTNZ	MRSQJRZXUSMNMUPXWNIO		2010-03-23 09:29:10 UTC	2010-04-21 19:50:04 UTC	29d 10h 20m 54s		
16	<input type="checkbox"/>	[XTNZ]-CXDTLZNAZJUNTVXAQQGW	[+] XTNZ	CXDTLZNAZJUNTVXAQQGW		2010-03-26 13:21:48 UTC	2010-04-21 19:50:04 UTC	26d 6h 28m 16s		
17	<input type="checkbox"/>	[XTNZ]-XHWQDYUJZHYMYPQJRM	[+] XTNZ	XHWQDYUJZHYMYPQJRM		2010-03-10 13:55:54 UTC	2010-04-21 19:49:49 UTC	12d 5h 53m 51s		
18	<input type="checkbox"/>	[XTNZ]-INYDMRYRROACSSBBDTZP	[+] XTNZ	INYDMRYRROACSSBBDTZP		2010-03-17 19:06:28 UTC	2010-04-21 19:49:45 UTC	35d 0h 43m 17s		
19	<input type="checkbox"/>	[XTNZ]-SESLQOPVICGZVOKWYIUN	[+] XTNZ	SESLQOPVICGZVOKWYIUN		2010-03-21 15:16:34 UTC	2010-04-21 19:49:45 UTC	31d 3h 33m 11s		
20	<input type="checkbox"/>	[XTNZ]-XPINCQGRUCQKRBNCOTN	[+] XTNZ	XPINCQGRUCQKRBNCOTN		2010-03-30 21:07:09 UTC	2010-04-21 19:49:45 UTC	21d 22h 42m 36s		
21	<input type="checkbox"/>	[XTNZ]-EKSHESSIDURPILYTPBDO	[+] XTNZ	EKSHESSIDURPILYTPBDO		2010-04-01 10:27:41 UTC	2010-04-21 19:49:45 UTC	20d 9h 22m 4s		
22	<input type="checkbox"/>	[XTNZ]-DGBJOWSITUEJNCQVEXCHL	[+] XTNZ	DGBJOWSITUEJNCQVEXCHL		2010-03-22 08:37:13 UTC	2010-04-21 19:49:44 UTC	30d 11h 12m 31s		
23	<input type="checkbox"/>	[XTNZ]-DEFZDNZVJKQHZAOJXFHU	[+] XTNZ	DEFZDNZVJKQHZAOJXFHU		2010-03-31 13:04:41 UTC	2010-04-21 19:49:44 UTC	21d 6h 45m 3s		
24	<input type="checkbox"/>	[XTNZ]-CTVEMNPOOQOOLSYZSUTJ	[+] XTNZ	CTVEMNPOOQOOLSYZSUTJ		2009-12-01 15:04:12 UTC	2010-04-21 19:49:39 UTC	141d 4h 45m 18s		
25	<input type="checkbox"/>	[XTNZ]-HUTANSCBIQKQZLXVEA	[+] XTNZ	HUTANSCBIQKQZLXVEA		2010-03-18 06:54:59 UTC	2010-04-21 19:49:30 UTC	34d 12h 51m 31s		
26	<input type="checkbox"/>	[XTNZ]-POUUCQTDERTYRJUMJRAL	[+] XTNZ	POUUCQTDERTYRJUMJRAL		2010-03-21 21:16:16 UTC	2010-04-21 19:49:30 UTC	30d 22h 33m 14s		
27	<input type="checkbox"/>	[XTNZ]-MCKRFLNMZQXIBLAUCH	[+] XTNZ	MCKRFLNMZQXIBLAUCH		2010-03-22 13:01:02 UTC	2010-04-21 19:49:30 UTC	30d 9h 48m 28s		
28	<input type="checkbox"/>	[XTNZ]-OSLIDENWBASQVLEUQGT	[+] XTNZ	OSLIDENWBASQVLEUQGT		2010-03-23 09:58:09 UTC	2010-04-21 19:49:30 UTC	29d 9h 51m 21s		

File Edit View History Bookmarks Tools Help

Most Visited Getting Started Latest Headlines

BotInstances: index BotInstances: show

Herds: [Bots] [Connected Bots] [Bot Types] [Machines] [IP Usages] [Countries] [Command Recurrences] [Command Types] Logged in as: 73002

Refresh Every Minute

For Herd 'My New Herd' ([Connected] | All) Displaying BotInstances 1 - 30 of 40 in total

[Previous](#) [Next](#)
 Per Page: [25](#) < [50](#) < [100](#) < All

	[+]	Bot Instance	Bot Type	Machine	Last Observed IP	First Callback Time	Last Callback Time	Lifetime	Country	Binary Key
1	<input type="checkbox"/>	[XTNZ]-Q-TRJEDWUXFBNDMODQNI	[+] XTNZ	DHTRJEDWUXFBNDMODQNI		2010-03-23 04:44:10 UTC	2010-04-21 19:50:29 UTC	29d 15h 6m 10s		
2	<input type="checkbox"/>	[XTNZ]-JERBDBEDPIYKOWDJUHH	[+] XTNZ	JERBDBEDPIYKOWDJUHH		2010-03-27 13:14:09 UTC	2010-04-21 19:50:29 UTC	25d 6h 36m 20s		
3	<input type="checkbox"/>	[XTNZ]-DOKISEYUKYXHKRZV_POC	[+] XTNZ	ODKISEYLYRXHKRZVTPOC		2010-04-01 19:50:29 UTC	2010-04-21 19:50:29 UTC	20d 0h 43m 10s		
4	<input type="checkbox"/>	[XTNZ]-FTYIQJZMAMMHHIGTYEVRG	[+] XTNZ	FTYIQJZMAMMHHIGTYEVRG		2010-04-01 20:34:06 UTC	2010-04-21 19:50:29 UTC	19d 23h 16m 23s		
5	<input type="checkbox"/>	[XTNZ]-AFWIDMODPKVKTZNMDDUC	[+] XTNZ	AFWIDMODPKVKTZNMDDUC		2010-04-01 20:34:19 UTC	2010-04-21 19:50:29 UTC	19d 23h 16m 10s		
6	<input type="checkbox"/>	[XTNZ]-SRUKDFYTOGIVWCHAWYTL	[+] XTNZ	SRUKDFYTOGIVWCHAWYTL		2010-04-01 20:52:52 UTC	2010-04-21 19:50:29 UTC	19d 22h 37m 37s		
7	<input type="checkbox"/>	[XTNZ]-WHOBIGFYHISMBGCFMZSH	[+] XTNZ	WHOBIGFYHISMBGCFMZSH		2010-03-22 21:36:37 UTC	2010-04-21 19:50:24 UTC	30d 22h 13m 47s		
8	<input type="checkbox"/>	[XTNZ]-NGVWGSPPCADOOMSVIVDW	[+] XTNZ	NGVWGSPPCADOOMSVIVDW		2010-03-29 10:25:28 UTC	2010-04-21 19:50:18 UTC	23d 9h 24m 50s		
9	<input type="checkbox"/>	[XTNZ]-LOKUNPHCHTSWOZULOPPR	[+] XTNZ	LOKUNPHCHTSWOZULOPPR		2010-03-22 10:39:07 UTC	2010-04-21 19:50:16 UTC	30d 9h 11m 9s		
10	<input type="checkbox"/>	[XTNZ]-Q-ASZJMBRYMXXKMFYKTA	[+] XTNZ	QHASZJMBRYMXXKMFYKTA		2010-03-27 01:46:33 UTC	2010-04-21 19:50:14 UTC	25d 18h 3m 41s		
11	<input type="checkbox"/>	[XTNZ]-YWGGEFULROUZWJIFOC	[+] XTNZ	YWGGEFULROUZWJIFOC		2009-11-30 05:15:05 UTC	2010-04-21 19:50:09 UTC	142d 14h 35m 1s		
12	<input type="checkbox"/>	[XTNZ]-JUBJ-BWCKTSHOXXXSHNG	[+] XTNZ	JUBJ-BWCKTSHOXXXSHNG		2010-03-17 18:49:34 UTC	2010-04-21 19:50:06 UTC	35d 1h 0m 32s		
13	<input type="checkbox"/>	[XTNZ]-JUCWOTDONOFGUAROSVOX	[+] XTNZ	JUCWOTDONOFGUAROSVOX		2010-03-22 03:17:53 UTC	2010-04-21 19:50:04 UTC	30d 16h 32m 11s		
14	<input type="checkbox"/>	[XTNZ]-AGFXNMRSAJAGXTHI_OFA	[+] XTNZ	AGFXNMRSAJAGXTHI_OFA		2010-03-22 05:23:50 UTC	2010-04-21 19:50:04 UTC	30d 13h 26m 14s		
15	<input type="checkbox"/>	[XTNZ]-MRSQJZKXUSMHNJPRXWNIQ	[+] XTNZ	MRSQJZKXUSMHNJPRXWNIQ		2010-03-23 09:29:10 UTC	2010-04-21 19:50:04 UTC	29d 10h 20m 54s		
16	<input type="checkbox"/>	[XTNZ]-CXDTLZNAZJNTVXAQJGW	[+] XTNZ	CXDTLZNAZJNTVXAQJGW		2010-03-26 13:21:48 UTC	2010-04-21 19:50:04 UTC	26d 6h 28m 16s		
17	<input type="checkbox"/>	[XTNZ]-XHWODYTILZFYMPYQJRM	[+] XTNZ	XHWODYTILZFYMPYQJRM		2010-03-31 13:55:54 UTC	2010-04-21 19:49:49 UTC	42d 5h 53m 51s		
18	<input type="checkbox"/>	[XTNZ]-INYDMRYRROACSSBBDTZP	[+] XTNZ	INYDMRYRROACSSBBDTZP		2010-03-17 19:06:28 UTC	2010-04-21 19:49:45 UTC	35d 0h 43m 17s		
19	<input type="checkbox"/>	[XTNZ]-SESLOQPVICGZVOKWIVUN	[+] XTNZ	SESLOQPVICGZVOKWIVUN		2010-03-21 16:16:34 UTC	2010-04-21 19:49:45 UTC	31d 3h 33m 11s		
20	<input type="checkbox"/>	[XTNZ]-XPINCGRUCIKRBNCDTN	[+] XTNZ	XPINCGRUCIKRBNCDTN		2010-03-30 21:07:09 UTC	2010-04-21 19:49:45 UTC	21d 22h 42m 36s		
21	<input type="checkbox"/>	[XTNZ]-EKSHESSIDURPILYTPBDO	[+] XTNZ	EKSHESSIDURPILYTPBDO		2010-04-01 10:27:41 UTC	2010-04-21 19:49:45 UTC	20d 9h 22m 4s		
22	<input type="checkbox"/>	[XTNZ]-UGBCUWGTUBUCOVEXCHL	[+] XTNZ	UGBCUWGTUBUCOVEXCHL		2010-03-22 08:37:13 UTC	2010-04-21 19:49:44 UTC	30d 11h 12m 31s		
23	<input type="checkbox"/>	[XTNZ]-DEFZDNZVJKCHZAJXFHU	[+] XTNZ	DEFZDNZVJKCHZAJXFHU		2010-03-31 13:04:41 UTC	2010-04-21 19:49:44 UTC	21d 6h 45m 3s		
24	<input type="checkbox"/>	[XTNZ]-CTVEMNPOOQOOLSZY2UTJ	[+] XTNZ	CTVEMNPOOQOOLSZY2UTJ		2009-12-01 15:04:12 UTC	2010-04-21 19:49:39 UTC	141d 4h 45m 18s		
25	<input type="checkbox"/>	[XTNZ]-HUTANSCBIQKLCZLVEA	[+] XTNZ	HUTANSCBIQKLCZLVEA		2010-03-18 06:54:59 UTC	2010-04-21 19:49:30 UTC	34d 12h 54m 31s		
26	<input type="checkbox"/>	[XTNZ]-POUUCOTDEDTYRJMJBAL	[+] XTNZ	POUUCOTDEDTYRJMJBAL		2010-03-21 21:16:16 UTC	2010-04-21 19:49:30 UTC	30d 22h 33m 14s		
27	<input type="checkbox"/>	[XTNZ]-NCCRFJINMXUKJIBLAUCH	[+] XTNZ	NCCRFJINMXUKJIBLAUCH		2010-03-22 10:01:02 UTC	2010-04-21 19:49:30 UTC	30d 9h 48m 28s		
28	<input type="checkbox"/>	[XTNZ]-OSLIDENWBASOUVLEUGT	[+] XTNZ	OSLIDENWBASOUVLEUGT		2010-03-23 09:58:09 UTC	2010-04-21 19:49:30 UTC	29d 9h 51m 21s		

File Edit View History Bookmarks Tools Help

Most Visited Getting Started Latest Headlines

BotInstances: edit BotInstances: show

[Herd] [Bots] [Connected Bots] [Bot Types] [Machines] [IP Usages] [Countries] [Command Recurrences] [Command Types] Logged in as: 73862

Editing Herd 'My New Herd' < [M] [X] >

<p>update herd ...</p> <p>Stay Here</p> <p>View Herd</p> <p>View Connected Herd</p> <p>View Index</p>	Bot Types (<input checked="" type="radio"/> Any Of <input type="radio"/> None Of)	Currently In Country (Any)	Currently In Netblock (Any)
	Choose A Bot Type	Choose A Country	Add Netblock
	<input checked="" type="checkbox"/> XINZ	Ever In Country (Any)	Historically In Netblock (Any)
		Choose A Country	Add Netblock
		Bot Instances (Any)	Add Bot Instance

File Edit View History Bookmarks Tools Help

Most Visited Getting Started Latest Headlines

BotInstances: edit BotInstances: show

[Herd] [Bots] [Connected Bots] [Bot Types] [Machines] [IP Usages] [Countries] [Command Recurrences] [Command Types] Logged in as: [REDACTED]

Editing Herd 'My New Herd' ◀ [M] ▼ ▶

Update and ...

Stay Here

View Herd

View Connected Herd

View Index

Bot Types (Any OF | None OF)

Choose A Bot Type

XTNZ

Currently In Country (Any)

Choose A Country

Currently In Netblock (Any)

Add Netblock

Historically In Netblock (Any)

Add Netblock

Bot Instances (Any)

Add Bot Instance

File Edit View History Bookmarks Tools Help

Most Visited Getting Started Latest Headlines

BotInstances: edit BotInstances: show

[Herd] [Bots] [Connected Bots] [Bot Types] [Machines] [IP Usages] [Countries] [Command Recurrences] [Command Types] Logged in as [redacted]

Editing Herd 'My New Herd' < [M] [X] >

Operate and ... [Stay Here] [View Herd] [View Connected Herd] [View Index]	Bot Types (<input checked="" type="radio"/> Any Of <input type="radio"/> None Of)	Currently In Country (<input checked="" type="radio"/> Any Of <input type="radio"/> None Of)	Currently In Netblock (Any)
	Choose A Bot Type	Choose A Country	[] [Add Netblock]
	<input checked="" type="checkbox"/> XTNZ	<input checked="" type="checkbox"/> Pakistan	Historically In Netblock (Any)
		Ever In Country (Any)	[] [Add Netblock]
	Choose A Country	Bot Instances (Any)	[] [Add Bot Instance]

File Edit View History Bookmarks Tools Help

Most Visited Getting Started Latest Headlines

BotInstances: edit BotInstances: show

[Herds] [Bots] [Connected Bots] [Bot Types] [Machines] [IP Usages] [Countries] [Command Recurrences] [Command Types] Logged in as [redacted]

Editing Herd 'My New Herd' < [M] [X] >

<p>update and ...</p> <p>Stay Here</p> <p>View Herd</p> <p>View Connected Herd</p> <p>View Index</p>	Bot Types (<input checked="" type="radio"/> Any Of <input type="radio"/> None Of)	Currently In Country (<input checked="" type="radio"/> Any Of <input type="radio"/> None Of)	Currently In Netblock (Any)
	Choose A Bot Type	Choose A Country	Add Netblock
	<input checked="" type="checkbox"/> XTNZ	<input checked="" type="checkbox"/> Pakistan	Historically In Netblock (Any)
	Ever In Country (Any)	Choose A Country	Add Netblock
			Bot Instances (Any)
			Add Bot Instance

File Edit View History Bookmarks Tools Help

Most Visited Getting Started Latest Headlines

BotInstances: index BotInstances: show

Herds: [Bots] [Connected Bots] [Bot Types] [Machines] [IP Usages] [Countries] [Command Recurrences] [Command Types] Logged in as: 73882

Refresh Every Minute

For Herd 'My New Herd' (Connected | [All])

Displaying BotInstances 1 - 30 of 1655 in total

« Previous 1 2 3 4 5 6 7 8 9 ... 55 56 Next »
 Per Page: 25 < 50 < 100 < All

	[+]	Bot Instance	Bot Type	Machine	Last Command	First Callback Time	Last Callback Time	Lifetime	Country	Binary Key
1	<input type="checkbox"/>	[XTNZ]-ODKISFYLRYXHKRZVTPQC	[+] XTNZ	ODKISFYLRYXHKRZVTPQC		2010-04-01 19:07:19 UTC	2010-04-21 19:57:17 UTC	20d 0h 49m 58s		
2	<input type="checkbox"/>	[XTNZ]-JEBPDBEDPIYKOWDJUHH	[+] XTNZ	JEBPDBEDPIYKOWDJUHH		2010-03-27 13:14:09 UTC	2010-04-21 19:56:41 UTC	25d 0h 42m 32s		
3	<input type="checkbox"/>	[XTNZ]-UCWQTDONOFUJAROSVOX	[+] XTNZ	UCWQTDONOFUJAROSVOX		2010-03-22 09:17:53 UTC	2010-04-21 19:56:21 UTC	31d 16h 38m 28s		
4	<input type="checkbox"/>	[XTNZ]-OHTFJEDWUXFBNDMODQNI	[+] XTNZ	OHTFJEDWUXFBNDMODQNI		2010-03-21 04:44:10 UTC	2010-04-21 19:56:21 UTC	29d 15h 12m 11s		
5	<input type="checkbox"/>	[XTNZ]-XPINCPGRUCIKRBNCDTN	[+] XTNZ	XPINCPGRUCIKRBNCDTN		2010-03-30 23:07:09 UTC	2010-04-21 19:55:54 UTC	21d 22h 48m 45s		
6	<input type="checkbox"/>	[XTNZ]-OCBCUWGTUBUNCOVEXOPL	[+] XTNZ	OCBCUWGTUBUNCOVEXOPL		2010-03-22 08:37:13 UTC	2010-04-21 19:55:53 UTC	30d 11h 13m 40s		
7	<input type="checkbox"/>	[XTNZ]-DFEZDNZVJKOHAQJXEHU	[+] XTNZ	DFEZDNZVJKOHAQJXEHU		2010-03-31 13:04:41 UTC	2010-04-21 19:55:52 UTC	21d 6h 51m 12s		
8	<input type="checkbox"/>	[XTNZ]-CTVEMNP0000LSYZSUTJ	[+] XTNZ	CTVEMNP0000LSYZSUTJ		2009-12-01 15:14:12 UTC	2010-04-21 19:55:38 UTC	141d 4h 51m 26s		
9	<input type="checkbox"/>	[XTNZ]-OSLTOENWRBASOUVLEILOGT	[+] XTNZ	OSLTOENWRBASOUVLEILOGT		2010-03-23 09:50:09 UTC	2010-04-21 19:55:38 UTC	29d 9h 57m 29s		
10	<input type="checkbox"/>	[XTNZ]-UUP-EOOPCOMPZHSACZCI	[+] XTNZ	UUPHEOOPCOMPZHSADZCI		2010-03-30 11:36:17 UTC	2010-04-21 19:55:38 UTC	22d 8h 19m 21s		
11	<input type="checkbox"/>	[XTNZ]-WFMOPBEKUHKEZFMIBLWBL	[+] XTNZ	WFMOPBEKUHKEZFMIBLWBL		2010-03-30 17:32:00 UTC	2010-04-21 19:55:38 UTC	22d 2h 22m 58s		
12	<input type="checkbox"/>	[XTNZ]-AINARRMDZQIKRRIUZDI	[+] XTNZ	AINARRMDZQIKRRIUZDI		2010-04-01 19:11:19 UTC	2010-04-21 19:55:38 UTC	21d 0h 44m 19s		
13	<input type="checkbox"/>	[XTNZ]-NLEEGIEKSLEITLEYAVUE	[+] XTNZ	NLEEGIEKSLEITLEYAVUE		2010-03-30 11:51:05 UTC	2010-04-21 19:55:22 UTC	22d 8h 4m 17s		
14	<input type="checkbox"/>	[XTNZ]-XTOTDFIKIZFLINKOKIWW	[+] XTNZ	XTOTDFIKIZFLINKOKIWW		2010-03-29 22:34:02 UTC	2010-04-21 19:55:04 UTC	22d 21h 21m 2s		
15	<input type="checkbox"/>	[XTNZ]-HOFDPPYCKFKGDDGAHHS	[+] XTNZ	HOFDPPYCKFKGDDGAHHS		2010-03-30 10:46:34 UTC	2010-04-21 19:49:51 UTC	22d 0h 57m 17s		
16	<input type="checkbox"/>	[XTNZ]-BMINPROBLIEQAQAWWYDN	[+] XTNZ	BMINPROBLIEQAQAWWYDN		2010-03-22 07:29:36 UTC	2010-04-21 19:43:23 UTC	30d 12h 13m 47s		
17	<input type="checkbox"/>	[XTNZ]-QWVZLCRMTLDVICCEUORL	[+] XTNZ	QWVZLCRMTLDVICCEUORL		2010-03-30 19:28:41 UTC	2010-04-21 19:43:23 UTC	22d 0h 14m 42s		
18	<input type="checkbox"/>	[XTNZ]-VZAIHOEDBSQIOZGHHANS	[+] XTNZ	VZAIHOEDBSQIOZGHHANS		2010-03-22 09:51:26 UTC	2010-04-21 19:39:46 UTC	30d 9h 48m 20s		
19	<input type="checkbox"/>	[XTNZ]-MMTOWYCHCZRTIUPSAKUIA	[+] XTNZ	MMTOWYCHCZRTIUPSAKUIA		2010-04-01 19:15:17 UTC	2010-04-21 19:39:29 UTC	20d 0h 5m 11s		
20	<input type="checkbox"/>	[XTNZ]-XLDIZDUHZSZWYBUMKHTF	[+] XTNZ	XLDIZDUHZSZWYBUMKHTF		2010-03-27 13:14:29 UTC	2010-04-21 19:16:17 UTC	25d 6h 1m 48s		
21	<input type="checkbox"/>	[XTNZ]-XYBKUJALLWATCCTHIEKU	[+] XTNZ	XYBKUJALLWATCCTHIEKU		2010-03-22 09:18:12 UTC	2010-04-21 19:12:42 UTC	30d 9h 54m 30s		
22	<input type="checkbox"/>	[XTNZ]-R00CGYRAFWWLHACLDUG	[+] XTNZ	R00CGYRAFWWLHACLDUG		2010-03-31 14:22:32 UTC	2010-04-21 19:09:12 UTC	21d 5h 46m 40s		
23	<input type="checkbox"/>	[XTNZ]-GJPDFSZHXIBYGOIRCBXC	[+] XTNZ	GJPDFSZHXIBYGOIRCBXC		2010-03-30 08:04:43 UTC	2010-04-21 19:08:54 UTC	22d 11h 2m 11s		
24	<input type="checkbox"/>	[XTNZ]-U00XYEQOSLVFHVAFHCJH	[+] XTNZ	U00XYEQOSLVFHVAFHCJH		2010-04-01 19:01:54 UTC	2010-04-21 19:16:35 UTC	21d 16h 4m 41s		
25	<input type="checkbox"/>	[XTNZ]-ILWCIYNSTCILDHOWZAO	[+] XTNZ	ILWCIYNSTCILDHOWZAO		2010-03-29 09:18:42 UTC	2010-04-21 19:05:38 UTC	29d 9h 46m 56s		
26	<input type="checkbox"/>	[XTNZ]-NBGJNFLTJASAGJFGMDO	[+] XTNZ	NBGJNFLTJASAGJFGMDO		2010-03-25 21:33:26 UTC	2010-04-21 19:02:44 UTC	22d 21h 29m 18s		
27	<input type="checkbox"/>	[XTNZ]-DAEJYZO-NYHJRKBDDBWU	[+] XTNZ	DAEJYZO-NYHJRKBDDBWU		2010-04-01 19:08:31 UTC	2010-04-21 19:01:55 UTC	19d 23h 53m 24s		
28	<input type="checkbox"/>	[XTNZ]-ILXINQXWXMVQIANCXLZ	[+] XTNZ	ILXINQXWXMVQIANCXLZ		2010-03-31 14:03:27 UTC	2010-04-21 19:05:07 UTC	21d 4h 50m 40s		

File Edit View History Bookmarks Tools Help

Most Visited Getting Started Latest Headlines

BotInstances: index BotInstances: show

Herds: [Bots] [Connected Bots] [Bot Types] [Machines] [IP Usages] [Countries] [Command Recurrences] [Command Types] Logged in as: [REDACTED] Refresh Every Minute

For Herd 'My New Herd' (Connected | [All]) Displaying BotInstances 1 - 30 of 1655 in total

« Previous 1 2 3 4 5 6 7 8 9 ... 55 56 Next »
Per Page: 25 < 100 > All

	[+]	Bot Instance	Bot Type	Machine	Last Observed IP	First Callback Time	Last Callback Time ▼	Lifetime	Country	Binary Key
1	<input type="checkbox"/>	[XTNZ]-ODKISFVLRVXHKRZVTPQC	[+] XTNZ	ODKISFVLRVXHKRZVTPQC	[REDACTED]	2010-04-01 19:07:19 UTC	2010-04-21 19:57:17 UTC	20d 0h 49m 58s	[REDACTED]	
2	<input type="checkbox"/>	[XTNZ]-JEBPDBEDPIYKOWDJUHH	[+] XTNZ	JEBPDBEDPIYKOWDJUHH	[REDACTED]	2010-03-27 18:14:09 UTC	2010-04-21 19:56:41 UTC	25d 0h 42m 32s	[REDACTED]	
3	<input checked="" type="checkbox"/>	[XTNZ]-UUCWQIUCRQJFGUAKUSVQX	[+] XTNZ	UUCWQIUCRQJFGUAKUSVQX	[REDACTED]	2010-03-25 13:17:53 UTC	2010-04-21 19:56:21 UTC	30d 16h 38m 28s	[REDACTED]	
4	<input checked="" type="checkbox"/>	[XTNZ]-OHTFJEDWUXFBNDMDDQNI	[+] XTNZ	OHTFJEDWUXFBNDMDDQNI	[REDACTED]	2010-03-23 04:44:10 UTC	2010-04-21 19:56:21 UTC	29d 15h 12m 11s	[REDACTED]	
5	<input checked="" type="checkbox"/>	[XTNZ]-XPINCPGRUCIKRBNCDTN	[+] XTNZ	XPINCPGRUCIKRBNCDTN	[REDACTED]	2010-03-30 21:07:09 UTC	2010-04-21 19:56:54 UTC	21d 22h 48m 45s	[REDACTED]	
6	<input checked="" type="checkbox"/>	[XTNZ]-OCBCUWGTUBUNCOVEXOPL	[+] XTNZ	OCBCUWGTUBUNCOVEXOPL	[REDACTED]	2010-03-22 08:37:13 UTC	2010-04-21 19:56:58 UTC	30d 11h 13m 40s	[REDACTED]	
7	<input checked="" type="checkbox"/>	[XTNZ]-DFEFDNZVJKOHZAQJXFHU	[+] XTNZ	DFEFDNZVJKOHZAQJXFHU	[REDACTED]	2010-03-31 18:04:41 UTC	2010-04-21 19:56:58 UTC	21d 6h 51m 12s	[REDACTED]	
8	<input type="checkbox"/>	[XTNZ]-CTVEMNP0000QLSYZSUTJ	[+] XTNZ	CTVEMNP0000QLSYZSUTJ	[REDACTED]	2009-12-01 15:04:12 UTC	2010-04-21 19:56:38 UTC	141d 4h 51m 20s	[REDACTED]	
9	<input type="checkbox"/>	[XTNZ]-CSLTOENWRBASOUVLEUQGT	[+] XTNZ	CSLTOENWRBASOUVLEUQGT	[REDACTED]	2010-03-23 09:56:09 UTC	2010-04-21 19:56:38 UTC	29d 9h 57m 29s	[REDACTED]	
10	<input type="checkbox"/>	[XTNZ]-UUP-EOOPCOMPZHSACZCI	[+] XTNZ	UUPHEOOPCOMPZHSADZCI	[REDACTED]	2010-03-30 11:36:17 UTC	2010-04-21 19:56:38 UTC	22d 8h 19m 21s	[REDACTED]	
11	<input type="checkbox"/>	[XTNZ]-WFMQPEKEUHKZFMBLWBL	[+] XTNZ	WFMQPEKEUHKZFMBLWBL	[REDACTED]	2010-03-30 17:32:40 UTC	2010-04-21 19:56:38 UTC	22d 2h 22m 58s	[REDACTED]	
12	<input type="checkbox"/>	[XTNZ]-ALNAB4MLZOUJCKEKUZCIJ	[+] XTNZ	ALNAB4MLZOUJCKEKUZCIJ	[REDACTED]	2010-04-01 19:11:19 UTC	2010-04-21 19:56:38 UTC	20d 0h 44m 19s	[REDACTED]	
13	<input type="checkbox"/>	[XTNZ]-NLEEGIEKSLEITLEYAVUE	[+] XTNZ	NLEEGIEKSLEITLEYAVUE	[REDACTED]	2010-03-30 11:51:05 UTC	2010-04-21 19:56:22 UTC	22d 8h 4m 17s	[REDACTED]	
14	<input type="checkbox"/>	[XTNZ]-XTOTDFIKZFIINKOKIWW	[+] XTNZ	XTOTDFIKZFIINKOKIWW	[REDACTED]	2010-03-29 22:34:02 UTC	2010-04-21 19:56:04 UTC	22d 21h 21m 2s	[REDACTED]	
15	<input type="checkbox"/>	[XTNZ]-HOFDDPP-CYFKGDCGAHHS	[+] XTNZ	HOFDDPPYCKFKGDCGAHHS	[REDACTED]	2010-03-30 10:46:34 UTC	2010-04-21 19:49:51 UTC	22d 8h 57m 17s	[REDACTED]	
16	<input type="checkbox"/>	[XTNZ]-BMINPROBLIEQAQAWWYDN	[+] XTNZ	BMINPROBLIEQAQAWWYDN	[REDACTED]	2010-03-22 07:29:36 UTC	2010-04-21 19:48:23 UTC	30d 12h 13m 47s	[REDACTED]	
17	<input type="checkbox"/>	[XTNZ]-QVYZLQKRTLDVWIGGEUJRL	[+] XTNZ	QVYZLQKRTLDVWIGGEUJRL	[REDACTED]	2010-03-30 19:28:41 UTC	2010-04-21 19:48:23 UTC	22d 0h 14m 42s	[REDACTED]	
18	<input type="checkbox"/>	[XTNZ]-VZAIHOEDBSQIOZGHHANS	[+] XTNZ	VZAIHOEDBSQIOZGHHANS	[REDACTED]	2010-03-22 09:51:26 UTC	2010-04-21 19:39:46 UTC	30d 9h 40m 20s	[REDACTED]	
19	<input type="checkbox"/>	[XTNZ]-MMTQYCH-CZATUYE3PDI2	[+] XTNZ	MMTQYCH-CZATUYE3PDI2	[REDACTED]	2010-04-01 19:15:17 UTC	2010-04-21 19:20:28 UTC	20d 0h 5m 11s	[REDACTED]	
20	<input type="checkbox"/>	[XTNZ]-XLDI2DUH2S2WYBUMKHTE	[+] XTNZ	XLDI2DUH2S2WYBUMKHTE	[REDACTED]	2010-03-27 18:14:29 UTC	2010-04-21 19:16:17 UTC	25d 6h 1m 48s	[REDACTED]	
21	<input type="checkbox"/>	[XTNZ]-XYBKUJALLWATCCTHIEKU	[+] XTNZ	XYBKUJALLWATCCTHIEKU	[REDACTED]	2010-03-22 09:18:12 UTC	2010-04-21 19:12:42 UTC	30d 9h 54m 30s	[REDACTED]	
22	<input type="checkbox"/>	[XTNZ]-R00CGV8F8W7H4C100G	[+] XTNZ	R00CGV8F8W7H4C100G	[REDACTED]	2010-03-31 14:22:32 UTC	2010-04-21 19:09:12 UTC	21d 4h 46m 40s	[REDACTED]	
23	<input type="checkbox"/>	[XTNZ]-GJPDFSZHXIBYGOICBXC	[+] XTNZ	GJPDFSZHXIBYGOICBXC	[REDACTED]	2010-03-30 08:04:43 UTC	2010-04-21 19:06:54 UTC	22d 11h 2m 11s	[REDACTED]	
24	<input type="checkbox"/>	[XTNZ]-U0QXYEQ0SLVFHVAFHCJH	[+] XTNZ	U0QXYEQ0SLVFHVAFHCJH	[REDACTED]	2010-04-01 03:01:54 UTC	2010-04-21 19:16:35 UTC	20d 16h 4m 41s	[REDACTED]	
25	<input type="checkbox"/>	[XTNZ]-ILWCIYNSTCILDHOWZAO	[+] XTNZ	ILWCIYNSTCILDHOWZAO	[REDACTED]	2010-03-23 09:18:42 UTC	2010-04-21 19:05:38 UTC	29d 9h 46m 56s	[REDACTED]	
26	<input type="checkbox"/>	[XTNZ]-NBGJNFLTJ8ASGJFGMDO	[+] XTNZ	NBGJNFLTJ8ASGJFGMDO	[REDACTED]	2010-03-25 21:33:20 UTC	2010-04-21 19:02:44 UTC	22d 21h 29m 18s	[REDACTED]	
27	<input type="checkbox"/>	[XTNZ]-DAEIKZOLNYHJKBDBEJWL	[+] XTNZ	DAEIKZOLNYHJKBDBEJWL	[REDACTED]	2010-04-01 19:08:31 UTC	2010-04-21 19:01:55 UTC	19d 23h 53m 24s	[REDACTED]	
28	<input type="checkbox"/>	[XTNZ]-TLKINQXWKMZYQI2NCXLZ	[+] XTNZ	TLKINQXWKMZYQI2NCXLZ	[REDACTED]	2010-03-31 14:03:27 UTC	2010-04-21 19:04:07 UTC	21d 4h 50m 40s	[REDACTED]	

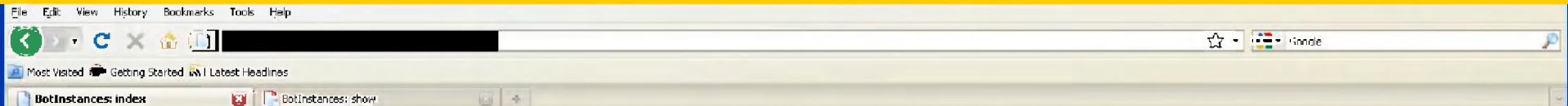

Herds: [Bots] [Connected Bots] [Bot Types] [Machines] [IP Usages] [Countries] [Command Recurrences] [Command Types]

Logged in as: [Redacted]
 Refresh Every Minute

For Herd 'My New Herd' (Connected | [All]) Displaying BotInstances 1 - 30 of 1655 in total

< Previous 1 2 3 4 5 6 7 8 9 ... 55 56 Next >
 Per Page: 25 < 100 < All

	Document herd with...	Bot Type	Machine	Last Observed IP	First Callback Time	Last Callback Time ▼	Lifetime	Country	Binary Key
1	Bot Instance	[+] XTNZ	OKRZVTPQC	ODKISEVLRVXHKRZVTPQC	2010-04-01 19:07:19 UTC	2010-04-21 19:57:17 UTC	20d 0h 49m 58s		
2	Bot Type	[+] XTNZ	KOWDUJHH	JEBPDBEDPIYKOWDUJHH	2010-03-27 18:14:09 UTC	2010-04-21 19:56:41 UTC	25d 6h 42m 32s		
3	Currently Has IP	[+] XTNZ	GUAROSVVOX	IUCWOTDONOFGUAROSVVOX	2010-03-22 09:17:53 UTC	2010-04-21 19:56:21 UTC	31d 16h 38m 28s		
4	Ever Had IP	[+] XTNZ	BNDMODQNI	OHTFIFDWLXFBNDMODQNI	2010-03-23 04:44:10 UTC	2010-04-21 19:56:21 UTC	29d 15h 12m 11s		
5	Currently In Country	[+] XTNZ	QBNCDFN	XPINCPGRUCIKQBNCDFN	2010-03-30 23:07:09 UTC	2010-04-21 19:55:54 UTC	21d 22h 48m 45s		
6	Ever In Country	[+] XTNZ	JNCOVEXOPL	JGRCUWGTUBUNCOVEXOPL	2010-03-22 08:37:13 UTC	2010-04-21 19:55:53 UTC	30d 11h 18m 40s		
7	Binary Key	[+] XTNZ	HZAOXPHL	DEFZFNZVJKQHZACJPHFLJ	2010-03-31 18:04:41 UTC	2010-04-21 19:55:52 UTC	21d 6h 51m 12s		
8	<input type="checkbox"/>	[+] XTNZ	CTYEMNPOOOOOLSYZSUTJ	CTYEMNPOOOOOLSYZSUTJ	2009-12-01 15:04:12 UTC	2010-04-21 19:55:38 UTC	141d 4h 51m 26s		
9	<input type="checkbox"/>	[+] XTNZ	OSLTOENWRBASOUVLEIJOGT	OSLTOENWRBASOUVLEIJOGT	2010-03-23 09:50:09 UTC	2010-04-21 19:55:38 UTC	29d 9h 57m 29s		
10	<input type="checkbox"/>	[+] XTNZ	JUFHEOOFCDMPZHSACZOC	JUFHEOOFCDMPZHSACZOC	2010-03-30 11:36:17 UTC	2010-04-21 19:55:38 UTC	22d 8h 19m 21s		
11	<input type="checkbox"/>	[+] XTNZ	WFMOPBEKHKZFMIBLWBL	WFMOPBEKHKZFMIBLWBL	2010-03-30 17:32:10 UTC	2010-04-21 19:55:38 UTC	22d 2h 22m 58s		
12	<input type="checkbox"/>	[+] XTNZ	ALNARKDZQJOKBRU2DJ	ALNARKDZQJOKBRU2DJ	2010-04-01 19:11:19 UTC	2010-04-21 19:55:38 UTC	21d 0h 44m 19s		
13	<input type="checkbox"/>	[+] XTNZ	NLEEGIEKSLITLFYAVUE	NLEEGIEKSLITLFYAVUE	2010-03-30 11:51:05 UTC	2010-04-21 19:55:38 UTC	22d 8h 4m 17s		
14	<input type="checkbox"/>	[+] XTNZ	XTOTDFIKIZFLINKOKIWW	XTOTDFIKIZFLINKOKIWW	2010-03-29 22:34:02 UTC	2010-04-21 19:55:04 UTC	22d 21h 21m 2s		
15	<input type="checkbox"/>	[+] XTNZ	HOFDDPPYCKFKGDDGAHHS	HOFDDPPYCKFKGDDGAHHS	2010-03-30 10:46:34 UTC	2010-04-21 19:49:51 UTC	22d 8h 57m 17s		
16	<input type="checkbox"/>	[+] XTNZ	BMINPROBLIEKAAQAWWYDN	BMINPROBLIEKAAQAWWYDN	2010-03-22 07:29:36 UTC	2010-04-21 19:48:23 UTC	30d 12h 13m 47s		
17	<input type="checkbox"/>	[+] XTNZ	QVVZLQRMTLDVICGEJURL	QVVZLQRMTLDVICGEJURL	2010-03-30 19:28:41 UTC	2010-04-21 19:48:23 UTC	22d 0h 14m 42s		
18	<input type="checkbox"/>	[+] XTNZ	VZAIHOEDBSQIOZGHHANS	VZAIHOEDBSQIOZGHHANS	2010-03-22 09:51:26 UTC	2010-04-21 19:39:46 UTC	30d 9h 48m 20s		
19	<input type="checkbox"/>	[+] XTNZ	MMTOVYCH CZATUVSRBDIA	MMTOVYCH CZATUVSRBDIA	2010-04-01 13:15:17 UTC	2010-04-21 19:26:28 UTC	20d 0h 5m 11s		
20	<input type="checkbox"/>	[+] XTNZ	XLDZCJHRSZSYBUMKHTF	XLDZCJHRSZSYBUMKHTF	2010-03-27 18:14:29 UTC	2010-04-21 19:16:17 UTC	25d 6h 1m 48s		
21	<input type="checkbox"/>	[+] XTNZ	XYBKUJALLWATCOETHIEKU	XYBKUJALLWATCOETHIEKU	2010-03-22 09:18:12 UTC	2010-04-21 19:12:42 UTC	30d 9h 54m 30s		
22	<input type="checkbox"/>	[+] XTNZ	RQCCGVRAPWWDHACIDUG	RQCCGVRAPWWDHACIDUG	2010-03-31 14:22:32 UTC	2010-04-21 19:09:12 UTC	21d 4h 46m 40s		
23	<input type="checkbox"/>	[+] XTNZ	GJPDFSZHXIBYGOIRCBXC	GJPDFSZHXIBYGOIRCBXC	2010-03-30 08:04:43 UTC	2010-04-21 19:08:54 UTC	22d 11h 2m 11s		
24	<input type="checkbox"/>	[+] XTNZ	UOQXYEQOSLVFHVAFHCJH	UOQXYEQOSLVFHVAFHCJH	2010-04-01 13:01:54 UTC	2010-04-21 19:16:35 UTC	21d 16h 4m 41s		
25	<input type="checkbox"/>	[+] XTNZ	ILWQIVNSTCILDHOWZAO	ILWQIVNSTCILDHOWZAO	2010-03-29 09:18:42 UTC	2010-04-21 19:05:38 UTC	29d 9h 46m 56s		
26	<input type="checkbox"/>	[+] XTNZ	NBJUNELTJASAGJFGMDO	NBJUNELTJASAGJFGMDO	2010-03-25 21:38:26 UTC	2010-04-21 19:02:44 UTC	22d 21h 29m 18s		
27	<input type="checkbox"/>	[+] XTNZ	DAEIVZOLNYHJRKBDDBWUJ	DAEIVZOLNYHJRKBDDBWUJ	2010-04-01 19:08:31 UTC	2010-04-21 19:01:55 UTC	19d 23h 53m 24s		
28	<input type="checkbox"/>	[+] XTNZ	ILXINQXWXMVQATANOXLZ	ILXINQXWXMVQATANOXLZ	2010-03-31 14:03:27 UTC	2010-04-21 19:04:07 UTC	21d 4h 50m 40s		

File Edit View History Bookmarks Tools Help

Most Visited Getting Started Latest Headlines

BotInstances: index BotInstances: show

[Herds] [Bots] [Connected Bots] [Bot Types] [Machines] [IP Usages] [Countries] [Command Resources] [Command Types] Logged In as: 73882

Refresh Every Minute

For Herd 'My New Herd' (Connected | [All]) Displaying BotInstances 1 - 30 of 1655 in total

* Previous 1 2 3 4 5 6 7 8 9 10 ... 55 56 Next *
Per Page: 25 < 50 < 100 < All

		Bot Instance	Bot Type	Machine	Last Observed IP	First Callback Time	Last Callback Time ▼	Lifetime	Country	Binary Key
1	<input type="checkbox"/>	[XTNZ]-ODKTRFVLRXWKRZVTPQC	[+] XTNZ	ODKTRFVLRXWKRZVTPQC	[REDACTED]	2010-04-01 19:07:18 UTC	2010-04-21 19:57:17 UTC	20d 0h 42m 58s	[REDACTED]	
2	<input type="checkbox"/>	[XTNZ]-JERBPDDBEDPIYKOWDJUHH	[+] XTNZ	JERBPDDBEDPIYKOWDJUHH	[REDACTED]	2010-03-27 13:14:05 UTC	2010-04-21 19:56:41 UTC	25d 6h 42m 32s	[REDACTED]	
3	<input checked="" type="checkbox"/>	[XTNZ]-IUCWOTDONOFGRSVOK	[+] XTNZ	IUCWOTDONOFGRSVOK	[REDACTED]	2010-03-22 03:17:53 UTC	2010-04-21 19:56:21 UTC	30d 16h 38m 28s	[REDACTED]	
4	<input checked="" type="checkbox"/>	[XTNZ]-OHTFIEDWUXFBANDMDDMI	[+] XTNZ	OHTFIEDWUXFBANDMDDMI	[REDACTED]	2010-03-23 04:44:10 UTC	2010-04-21 19:56:21 UTC	29d 15h 12m 11s	[REDACTED]	
5	<input checked="" type="checkbox"/>	[XTNZ]-XFINCPGRUOKQBANDJIN	[+] XTNZ	XFINCPGRUOKQBANDJIN	[REDACTED]	2010-03-30 21:07:08 UTC	2010-04-21 19:56:54 UTC	21d 22h 48m 45s	[REDACTED]	
6	<input checked="" type="checkbox"/>	[XTNZ]-OCACHWATHUHQOAVEXODI	[+] XTNZ	OCACHWATHUHQOAVEXODI	[REDACTED]	2010-03-22 08:37:13 UTC	2010-04-21 19:56:53 UTC	30d 11h 18m 40s	[REDACTED]	
7	<input checked="" type="checkbox"/>	[XTNZ]-DEFZDZVYKOHZAQJXFHU	[+] XTNZ	DEFZDZVYKOHZAQJXFHU	[REDACTED]	2010-03-31 13:04:41 UTC	2010-04-21 19:56:53 UTC	21d 6h 51m 12s	[REDACTED]	
8	<input type="checkbox"/>	[XTNZ]-CTVEMNP000CLSYZSUTJ	[+] XTNZ	CTVEMNP000CLSYZSUTJ	[REDACTED]	2009-12-01 15:04:12 UTC	2010-04-21 19:56:39 UTC	141d 4h 51m 25s	[REDACTED]	
9	<input type="checkbox"/>	[XTNZ]-OSLQENWBASOUVLEUQGT	[+] XTNZ	OSLQENWBASOUVLEUQGT	[REDACTED]	2010-03-23 04:44:10 UTC	2010-04-21 19:56:39 UTC	29d 9h 57m 29s	[REDACTED]	
10	<input type="checkbox"/>	[XTNZ]-IURHEQORQMPRZHSADZOI	[+] XTNZ	IURHEQORQMPRZHSADZOI	[REDACTED]	2010-03-23 04:44:10 UTC	2010-04-21 19:56:39 UTC	29d 9h 57m 29s	[REDACTED]	
11	<input type="checkbox"/>	[XTNZ]-WFMQPEKFUHXZFMIBLWLV	[+] XTNZ	WFMQPEKFUHXZFMIBLWLV	[REDACTED]	2010-03-23 04:44:10 UTC	2010-04-21 19:56:39 UTC	29d 9h 57m 29s	[REDACTED]	
12	<input type="checkbox"/>	[XTNZ]-AINARQMDZQOKRQJUZDI	[+] XTNZ	AINARQMDZQOKRQJUZDI	[REDACTED]	2010-03-23 04:44:10 UTC	2010-04-21 19:56:39 UTC	29d 9h 57m 29s	[REDACTED]	
13	<input type="checkbox"/>	[XTNZ]-NLEEGTEKSLITLEYAVUE	[+] XTNZ	NLEEGTEKSLITLEYAVUE	[REDACTED]	2010-03-23 04:44:10 UTC	2010-04-21 19:56:39 UTC	29d 9h 57m 29s	[REDACTED]	
14	<input type="checkbox"/>	[XTNZ]-XTQTEKIKZELNKOKLWV	[+] XTNZ	XTQTEKIKZELNKOKLWV	[REDACTED]	2010-03-23 04:44:10 UTC	2010-04-21 19:56:39 UTC	29d 9h 57m 29s	[REDACTED]	
15	<input type="checkbox"/>	[XTNZ]-HOFDDPRYCKEKQDQAHHS	[+] XTNZ	HOFDDPRYCKEKQDQAHHS	[REDACTED]	2010-03-30 10:45:34 UTC	2010-04-21 19:49:51 UTC	22d 0h 57m 17s	[REDACTED]	
16	<input type="checkbox"/>	[XTNZ]-PMINPROBLIEXAQAWWYDN	[+] XTNZ	PMINPROBLIEXAQAWWYDN	[REDACTED]	2010-03-22 07:29:36 UTC	2010-04-21 19:49:23 UTC	30d 12h 19m 47s	[REDACTED]	
17	<input type="checkbox"/>	[XTNZ]-QVYZLQVYLDVYQGSUORL	[+] XTNZ	QVYZLQVYLDVYQGSUORL	[REDACTED]	2010-03-30 19:28:41 UTC	2010-04-21 19:48:23 UTC	22d 0h 19m 42s	[REDACTED]	
18	<input type="checkbox"/>	[XTNZ]-YZAIHQEDBSOIQZGHHS	[+] XTNZ	YZAIHQEDBSOIQZGHHS	[REDACTED]	2010-03-22 09:51:26 UTC	2010-04-21 19:39:45 UTC	30d 9h 48m 20s	[REDACTED]	
19	<input type="checkbox"/>	[XTNZ]-MMTQYCHLCZRTIYSRBQIA	[+] XTNZ	MMTQYCHLCZRTIYSRBQIA	[REDACTED]	2010-04-01 19:15:17 UTC	2010-04-21 19:20:28 UTC	20d 0h 5m 11s	[REDACTED]	
20	<input type="checkbox"/>	[XTNZ]-XLDZDUKZSZWVAILMKHTE	[+] XTNZ	XLDZDUKZSZWVAILMKHTE	[REDACTED]	2010-03-27 13:14:20 UTC	2010-04-21 19:16:17 UTC	25d 6h 1m 03s	[REDACTED]	
21	<input type="checkbox"/>	[XTNZ]-XYBKUJALLWATCCTHIEXU	[+] XTNZ	XYBKUJALLWATCCTHIEXU	[REDACTED]	2010-03-22 09:18:12 UTC	2010-04-21 19:12:42 UTC	30d 5h 54m 30s	[REDACTED]	
22	<input type="checkbox"/>	[XTNZ]-BOJQGVHAFVWUJHAGJUGG	[+] XTNZ	BOJQGVHAFVWUJHAGJUGG	[REDACTED]	2010-03-31 14:22:32 UTC	2010-04-21 19:09:12 UTC	21d 4h 46m 40s	[REDACTED]	
23	<input type="checkbox"/>	[XTNZ]-GJPDFSZHXIBYGOIRCBXC	[+] XTNZ	GJPDFSZHXIBYGOIRCBXC	[REDACTED]	2010-03-30 08:04:43 UTC	2010-04-21 19:06:54 UTC	22d 11h 2m 11s	[REDACTED]	
24	<input type="checkbox"/>	[XTNZ]-UQUXYEQOSLVFHVAFHCJH	[+] XTNZ	UQUXYEQOSLVFHVAFHCJH	[REDACTED]	2010-04-01 09:01:54 UTC	2010-04-21 19:06:35 UTC	20d 16h 4m 41s	[REDACTED]	
25	<input type="checkbox"/>	[XTNZ]-UJWQVYVNSTQJLQHWZ&Q	[+] XTNZ	UJWQVYVNSTQJLQHWZ&Q	[REDACTED]	2010-03-23 09:18:42 UTC	2010-04-21 19:05:39 UTC	29d 0h 45m 55s	[REDACTED]	
26	<input type="checkbox"/>	[XTNZ]-NBGJNFJTJASAGJFGMDQ	[+] XTNZ	NBGJNFJTJASAGJFGMDQ	[REDACTED]	2010-03-29 21:38:36 UTC	2010-04-21 19:02:44 UTC	22d 21h 29m 18s	[REDACTED]	
27	<input type="checkbox"/>	[XTNZ]-DAEJYZOLNYHJKRDBRWU	[+] XTNZ	DAEJYZOLNYHJKRDBRWU	[REDACTED]	2010-04-01 19:08:31 UTC	2010-04-21 19:01:55 UTC	19d 23h 53m 24s	[REDACTED]	
28	<input type="checkbox"/>	[XTNZ]-TLXINQXWXZMYUTANQXLZ	[+] XTNZ	TLXINQXWXZMYUTANQXLZ	[REDACTED]	2010-03-31 14:03:27 UTC	2010-04-21 18:54:07 UTC	21d 4h 50m 40s	[REDACTED]	

Augment herd by 'Bot Instance'...

Choose the target herd...

Choose the target herd...

My New Herd

Some Awesome Herd

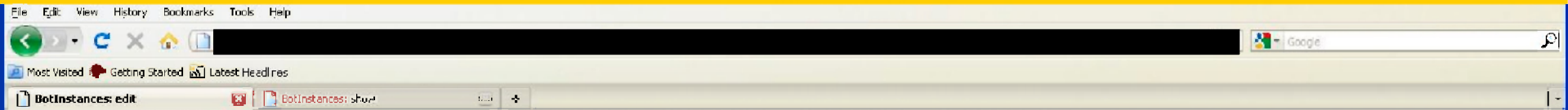

[Herds] [Bots] [Connected Bots] [Bot Types] [Machines] [IP Usages] [Countries] [Command Recurrences] [Command Types] Logged in as: 73662

Editing Herd 'My New Herd' ◀ | ↻ | ▶

Update Herd ...

Stay Here

View Herd

View Connected Herd

View Index

Bot Types (Any Of | None Of)

Choose A Bot Type

XTNZ

Currently In Country (Any Of | None Of)

Choose A Country

Division

Ever In Country (Any)

Choose A Country

Currently In Netblock (Any)

| Add Netblock

Historically In Netblock (Any)

| Add Netblock

Bot Instances (Any Of | None Of)

| Add Bot Instance

- [XTNZ]-IUCWQTDONQF6UAR,06VCR
- [XTNZ]-CHTF2EDWUKF3NDM0DDNI
- [XTNZ]-XPR,0PGRUCI4OR3NCDTN
- [XTNZ]-0GB0UWGTUBUNCOVEYOPL
- [XTNZ]-DFFZDNZVJKQHZAOJXFHU

TOP SECRET//COMINT//REL USA, FVEY

File Edit View History Bookmarks Tools Help

Most Visited Getting Started Latest Headlines

BotInstances: index BotInstances: show

[Herd] [Bots] [Connected Bots] [Bot Types] [Machines] [IP Usages] [Countries] [Command Recurrences] [Command Types]

Logged in as: 73662

Refresh Every Minute

For Herd 'My New Herd' (Connected | [All])
Displaying all 5 BotInstances

Per Page: 25 50 100 All

	[+]	Bot Instance	Bot Type	Machine	Last Callback Time	First Callback Time	Last Callback Time ▼	Lifetime	Country	Binary Key
1	<input type="checkbox"/>	[XTNZ]-IUCWOTDONDFGUARCSVOX	[+] XTNZ	IUCWOTDONDFGUARCSVOX	[REDACTED]	2010-03-22 03:17:53 UTC	2010-04-21 20:00:30 UTC	30d 16h 42m 37s	[+] PK	
2	<input type="checkbox"/>	[XTNZ]-XPINCPGRUCIKQRBNCDTN	[-] XTNZ	XPINCPGRUCIKQRBNCDTN	[REDACTED]	2010-03-30 21:07:09 UTC	2010-04-21 20:00:00 UTC	21d 22h 52m 51s	[+] PK	
3	<input type="checkbox"/>	[XTNZ]-GGBCUWGTJBUNCCYEXGPL	[+] XTNZ	GGBCUWGTJBUNCCYEXGPL	[REDACTED]	2010-03-22 06:37:13 UTC	2010-04-21 19:59:59 UTC	30d 11h 22m 46s	[+] PK	
4	<input type="checkbox"/>	[XTNZ]-DFEZDNZVJKOHZAOJXEHU	[+] XTNZ	DFEZDNZVJKOHZAOJXEHU	[REDACTED]	2010-03-31 13:04:41 UTC	2010-04-21 19:59:59 UTC	21d 0h 55m 18s	[+] PK	
5	<input type="checkbox"/>	[XTNZ]-OHTFJEDWUXFBNLMDONI	[-] XTNZ	OHTFJEDWUXFBNLMDONI	[REDACTED]	2010-03-24 01:44:10 UTC	2010-04-21 19:56:21 UTC	25d 15h 12m 11s	[+] PK	

File Edit View History Bookmarks Tools Help

Most Visited Getting Started Latest Headlines

BotInstances: index BotInstances: show

[Home] [Bots] [Connected Bots] [Bot Types] [Machines] [IP Usages] [Countries] [Command Recurrences] [Command Types]

Logged in as: 73882

Listing CommandRecurrences

New Command Recurrence

Edit	Erase
C_Dirwalk	Erase
demo_for_bob	Erase
Get_Process_Info	Erase
GetPmc2	Erase
more_dirwalks	Erase
More_dwaks	Erase
more_dwaks_2	Erase

New Command Recurrence

File Edit View History Bookmarks Tools Help

Most Visited Getting Started Latest Headlines

BotInstances: new BotInstances: show

[Herd] [Bots] [Connected Bots] [Bot Types] [Machines] [IP Usages] [Countries] [Command Recurrences] [Command Types] Logged in as: 73882

New Command Recurrence

Name

Command Type

Herd

File Edit View History Bookmarks Tools Help

Most Visited Getting Started Latest Headlines

BotInstances: new BotInstances: show

[Home] [Bots] [Connected Bots] [Bot Types] [Machines] [IP Usages] [Countries] [Command Recurrences] [Command Types]

Logged in as: 73662

New Command Recurrence

Name

Command Type
-- Select Command Type --
-- Select Command Type --
GetDirWalk
GetProcInfo

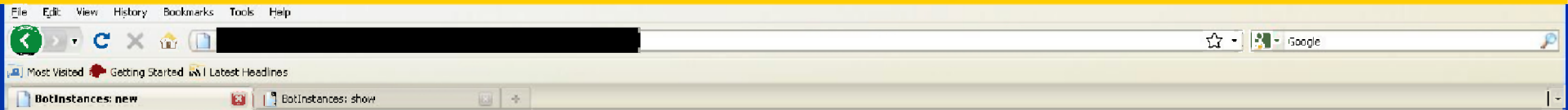

[Herd] [Bots] [Connected Bots] [Bot Types] [Machines] [IP Usages] [Countries] [Command Recurrences] [Command Types]

Logged in as: 73882

New Command Recurrence

Name

Command Type

Herd

Sub: Herd
My New Herd
paki.netblock
paki.xtnz
Some Awesome Herd

File Edit View History Bookmarks Tools Help

Most Visited Getting Started Latest Headlines

BotInstances: edit BotInstances: show

[Herd] [Bots] [Connected Bots] [Bot Types] [Machines] [IP Usages] [Countries] [Command Recurrences] [Command Types] Logged in as: 73882

CommandRecurrence was successfully created.

Editing Command Recurrence 'Dirwalks FTW'

Recurrence Name	Command Type Name	Herd Name
<input type="text" value="Dirwalks FTW"/>	<input type="text" value="GetDirWalk"/>	<input type="text" value="MyNewHerd"/>
Earliest Execution Time	Latest Execution Time	
<input type="text"/>	<input type="text"/>	
<input type="checkbox"/> Yes	Cycle Commands?	
<input type="checkbox"/> Yes	Broadcast Commands?	
<input type="text"/>	Maximum Total Executions For Herd	
<input type="text"/>	Maximum Total Executions Per Bot	
<input type="text"/>	Maximum Concurrent Executions For Herd	
<input type="text" value="1"/>	Maximum Concurrent Executions Per Bot	
<input type="text" value="0"/>	Delay Interval For Herd (seconds)	
<input type="text" value="0"/>	Delay Interval For Bot (seconds)	
<input type="button" value="Update"/>	<input type="button" value="Update And Activate"/>	<input type="button" value="Deactivate"/>
<input type="button" value="Add A Command Spec"/>	<input type="button" value="View Command Specs"/>	

File Edit View History Bookmarks Tools Help

Most Visited Getting Started Latest Headlines

BotInstances: edit BotInstances: show

[Herd] [Bots] [Connected Bots] [Bot Types] [Machines] [IP Usages] [Countries] [Command Recurrences] [Command Types]

Logged in as: 73862

CommandRecurrence was successfully created.

Editing Command Recurrence 'Dirwalks FTW'

Recurrence Name	Command Type Name	Herd Name																																										
<input type="text" value="Dirwalks FTW"/>	<input type="text" value="GetDirWalk"/>	<input type="text" value="MyNewHerd"/>																																										
Earliest Execution Time	Latest Execution Time																																											
<input type="text"/>	<input type="text"/>																																											
April 2010																																												
<table border="1"><thead><tr><th>Su</th><th>Mo</th><th>Tu</th><th>We</th><th>Th</th><th>Fr</th><th>Sa</th></tr></thead><tbody><tr><td></td><td></td><td></td><td></td><td>1</td><td>2</td><td>3</td></tr><tr><td>4</td><td>5</td><td>6</td><td>7</td><td>8</td><td>9</td><td>10</td></tr><tr><td>11</td><td>12</td><td>13</td><td>14</td><td>15</td><td>16</td><td>17</td></tr><tr><td>18</td><td>19</td><td>20</td><td>21</td><td>22</td><td>23</td><td>24</td></tr><tr><td>25</td><td>26</td><td>27</td><td>28</td><td>29</td><td>30</td><td></td></tr></tbody></table>			Su	Mo	Tu	We	Th	Fr	Sa					1	2	3	4	5	6	7	8	9	10	11	12	13	14	15	16	17	18	19	20	21	22	23	24	25	26	27	28	29	30	
Su	Mo	Tu	We	Th	Fr	Sa																																						
				1	2	3																																						
4	5	6	7	8	9	10																																						
11	12	13	14	15	16	17																																						
18	19	20	21	22	23	24																																						
25	26	27	28	29	30																																							
<input type="checkbox"/>	For Herd																																											
<input type="checkbox"/>	Per Bot																																											
<input type="checkbox"/>	Executions For Herd																																											
<input type="text" value="1"/>	Maximum Concurrent Executions Per Bot																																											
<input type="text" value="0"/>	Delay Interval For Herd (seconds)																																											
<input type="text" value="0"/>	Delay Interval For Bot (seconds)																																											
<input type="button" value="Update"/>	<input type="button" value="Update And Activate"/>	<input type="button" value="Deactivate"/>																																										
<input type="button" value="Add A Command Spec"/>		<input type="button" value="View Command Specs"/>																																										

File Edit View History Bookmarks Tools Help

Most Visited Getting Started Latest Headlines

BotInstances: edit BotInstances: show

[Herd] [Bots] [Connected Bots] [Bot Types] [Machines] [IP Usages] [Countries] [Command Recurrences] [Command Types]

Logged in as: 73882

CommandRecurrence was successfully created.

Editing Command Recurrence 'Dirwalks FTW'

Recurrence Name	Command Type Name	Herd Name
<input type="text" value="Dirwalks FTW"/>	<input type="text" value="GetDirWalk"/>	<input type="text" value="MyNewHerd"/>
Earliest Execution Time	Latest Execution Time	
<input type="text" value="04/22/2010"/>	<input type="text"/>	
<input checked="" type="checkbox"/> Yes	Cycle Commands?	
<input checked="" type="checkbox"/> Yes	Broadcast Commands?	
<input type="text"/>	Maximum Total Executions For Herd	
<input type="text"/>	Maximum Total Executions Per Bot	
<input type="text"/>	Maximum Concurrent Executions For Herd	
<input type="text" value="1"/>	Maximum Concurrent Executions Per Bot	
<input type="text" value="0"/>	Delay Interval For Herd (seconds)	
<input type="text" value="0"/>	Delay Interval For Bot (seconds)	
<input type="button" value="Update"/>	<input type="button" value="Update And Activate"/>	<input type="button" value="Deactivate"/>
<input type="button" value="Add A Command Spec"/>	<input type="button" value="View Command Specs"/>	

File Edit View History Bookmarks Tools Help

Most Visited Getting Started Latest Headlines

BotInstances: edit BotInstances: show

Logged in as: 73882

Editing Command Spec

[Previous Spec](#) [Command Recurrence](#)
[Delete This Spec](#)

<p>rootPath</p> <input type="text" value="C:\"/>
<p>recurseDepth</p> <input type="text" value="4"/>
<p>Update and go to...</p> <p><input type="button" value="Previous"/> <input type="button" value="Command Recurrence"/> <input type="button" value="Next"/></p>

File Edit View History Bookmarks Tools Help

Most Visited Getting Started Latest Headlines

BotInstances: edit BotInstances: show

[Herd] [Bots] [Connected Bots] [Bot Types] [Machines] [IP Usages] [Countries] [Command Recurrences] [Command Types]

Logged in as: 73882

CommandSpec was successfully updated.

Editing Command Recurrence 'Dirwalks FTW'

Recurrence Name	Command Type Name	Herd Name
<input type="text" value="Dirwalks FTW"/>	<input type="text" value="GetDirWalk"/>	<input type="text" value="MyNewHerd"/>
Earliest Execution Time	Latest Execution Time	
<input type="text"/>	<input type="text"/>	
<input checked="" type="checkbox"/> Yes	Cycle Commands?	
<input checked="" type="checkbox"/> Yes	Broadcast Commands?	
<input type="text"/>	Maximum Total Executions For Herd	
<input type="text"/>	Maximum Total Executions Per Bot	
<input type="text"/>	Maximum Concurrent Executions For Herd	
<input type="text" value="1"/>	Maximum Concurrent Executions Per Bot	
<input type="text" value="0"/>	Delay Interval For Herd (seconds)	
<input type="text" value="0"/>	Delay Interval For Bot (seconds)	
<input type="button" value="Update"/>	<input type="button" value="Update And Activate"/>	<input type="button" value="Deactivate"/>
<input type="button" value="Add A Command Spec"/>	<input type="button" value="View Command Specs"/>	

? You are about to activate this Command Recurrence. This will result in tasking being transmitted to Bot Instances. You will not be able to change this tasking once commenced, only cancel it. Are you sure you want to proceed?

OK Cancel

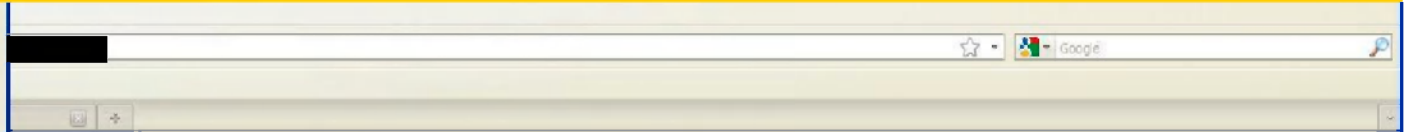

[Herd] [Dots] [Connected Dots] [Dot Types] [Machines] [IP Usages] [Countries] [Command Recurrences] [Command Types]

Logged In as: 70002

CommandSpec was successfully updated.

Editing Command Recurrence 'Dirwalks FTW'

Recurrence Name	Command Type Name	Herd Name
<input type="text" value="Dirwalks FTW"/>	<input type="text" value="GetDirWalk"/>	<input type="text" value="MyNewHerd"/>
Earliest Execution Time	Latest Execution Time	
<input type="text"/>	<input type="text"/>	
<input type="text" value="Yes"/> Yes	Cycle Commands?	
<input type="text" value="Yes"/> Yes	Broadcast Commands?	
<input type="text"/>	Maximum Total Executions For Herd	
<input type="text"/>	Maximum Total Executions Per Bot	
<input type="text"/>	Maximum Concurrent Executions For Herd	
<input type="text" value="1"/> 1	Maximum Concurrent Executions Per Bot	
<input type="text" value="0"/> 0	Delay Interval For Herd (seconds)	
<input type="text" value="0"/> 0	Delay Interval For Bot (seconds)	
<input type="button" value="Update"/>	<input type="button" value="Locate And Activate"/>	<input type="button" value="Deactivate"/>
<input type="button" value="Add A Command Spec"/>	<input type="button" value="View Command Specs"/>	

File Edit View History Bookmarks Tools Help

Most Visited Getting Started Latest Headlines

BotInstances: show BotInstances: show

[Home] [Bots] [Connected Bots] [Bot Types] [Machines] [IP Usages] [Countries] [Command Recurrences] [Command Types]

Logged in as: 73882

CommandRecurrence was successfully updated and activated.

Executions for Command Recurrence 'Dirwalks FTW'

Execution	Spec	Bot Instance	Creation Time	Transmission Time	Acknowledgement Time	Completion Time	Status
-----------	------	--------------	---------------	-------------------	----------------------	-----------------	--------